

TURH-TURA

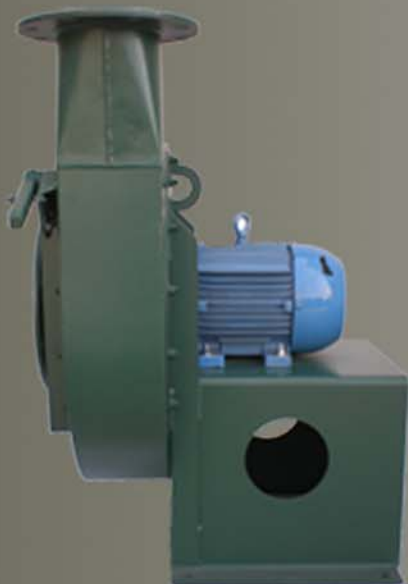

TODO EL AIRE QUE MEXICO REQUIERE



REGISTRO DE MARCA IMPI 515310

TURH - TURA

CARACTERISTICAS GENERALES



- Volumen hasta 5100 CFM.
- Presión hasta 56" columna de agua.
- Temperatura hasta 600 °F.
- Tamaños del 14" a 26".

ACCESORIOS

- Contra Brida
- Dren
- Filtro de succión
- Silenciador
- Compuerta de descarga
- Sello flecha
- Registro atornillado
- Base unitaria para arreglo 1.
- Guarda banda
- Guarda flecha
- Cople

ROTORES

Aluminio:

- Aminora el nivel de ruido proveyendo mayor eficiencia en su comportamiento.
- Al ser un material más ligero, rompe la inercia y aumenta la eficiencia y consume menos caballaje.
- El mamelón es en fundición de aluminio.

Acero:

- Radial.
- Acero al carbón, Acero Inoxidable.
- Algunas combinaciones de ventilador con motor pueden tener problemas de requerimiento del torque de arranque (consulte tabla 4).
- Mamelón de fierro colado.



CONSTRUCCIÓN ANTI-CHISPA

- AMCA "A" SRC
Incluye todas las partes en contacto con el aire, para temperatura máxima de 200°F.
- AMCA "B" SRC
Rotor y arillo alrededor de la caja y en la abertura de la flecha, para temperatura máxima de 200°F.

APLICACIONES

- Transportación Neumática
- Sistemas de Combustión
- Sistema para manejo de gases a alta presión

ARREGLOS DISPONIBLES

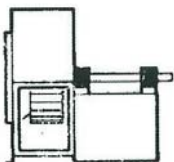

ARREGLO 1

Temperatura máxima:
Rotor de Acero a 300°F
Alta temperatura a 600 °F

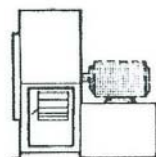

ARREGLO 4

Temperatura máxima:
180°F

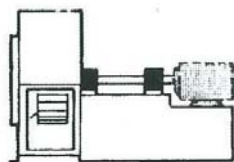

ARREGLO 8

Temperatura máxima:
Rotor de Acero a 300°F
Alta temperatura a 600 °F



ARREGLO 4V

Temperatura máxima:
180°F

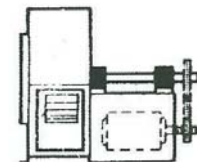

ARREGLO 10

Temperatura máxima:
Rotor de Acero a 300°F
Alta temperatura a 600 °F

CONSTRUCCIÓN PARA ALTAS TEMPERATURAS

Para altas temperaturas hasta 600°F contamos con el arreglo 1 y 8 que incluyen el rotor de enfriamiento para la flecha. Únicamente se fabrica en acero inoxidable o en acero al carbón. No se suministra el sello en la fecha y deberán efectuarse las correcciones pertinentes en las tablas.

Las partes en contacto con el aire con una soldadura ancha que evite corrosión en procesos corrosivos.

No olvide aplicar los factores de corrección en los rotores construidos en acero inoxidable.

COMO USAR LAS TABLAS

PASO	PROCEDIMIENTO	EJEMPLO
1	Para un volumen y presión conocido, las tablas de capacidad se utilizan para conocer tamaños, RPM de rotor, y BHP. Si la capacidad es a condiciones distintas a 70° F y nivel del mar o densidad estándar (0.0750 lb/pie ³), los factores de corrección deben aplicarse a presión estática y BHP.	Un sistema neumático que requiere 690 CFM contra una presión de 17 in wg. Que va a operar a 300° F y 4000 pies de altitud.
2	Si se requieren correcciones por temperatura altitud o densidad, determine los factores de corrección utilizando las tablas de factores de corrección.	Factor de corrección para 300° F es 1.43 Factor de corrección para 4000 pies es 1.16 Factor de corrección para -17 es 1.042 Factor final=1.43 x 1.16 x 1.042 = 1.728
3	Multiplique las condiciones operativas SP por los factores de corrección. Esto proporciona la SP equivalente a la densidad de 0.0750 lb/ft ³ .	La PE requerida por el ventilador con aire estándar es: 17" x 1.728= 29.37 en C.A.
4	Seleccione el ventilador, tamaño, RPM y BHP de las tablas de capacidad, NOTA: para un desempeño dado, los ventiladores más grandes son generalmente más eficientes y tendrán menor costo de operación en la vida útil del ventilador.	Un turbo ventilador modelo TURH 624 es seleccionado para 690 CFM a 29 C.A., 2693 RPM, 3.45 BHP (con aires estándar) densidad de 0.0750 lb/pie ³ .
5	Determine el BHP operativo al dividir BHP de las tablas de capacidad entre el factor de corrección utilizado en el paso 2.	BHP operativo es 3.45 / 1.728= 1.99 BHP.
6	Selección Final.	Un turboventilador TURH 624 para 690 CFM y 29" wg que va a girar a 2693 RPM y 1.99 BHP.

DESEMPEÑO

El desempeño esta basado en pies cubicos por minuto (CFM) en la succión del ventilador, a una densidad estándar de 0.75 lbs/ft³ y presión estática en la descarga del mismo. La presión estática está en columna de agua (CA).

Para una corrección adecuada es necesario considerar la densidad de aire cuando la densidad varía de .075 lbs/ft³ a 70 °F a nivel de mar. Esto también ocurre cuando existe presión estática negativa (rarificación) en la succión del ventilador.

Multiplique la presión estática requerida por los factores de las tablas 1, 2 y 3 para obtener la correcta presión.

La presión y BHP se reducirán a la inversa de estos factores.

Multiplique un factor por otro si la temperatura, altitud y la rarificación no son estándares.

Ejemplificando: Altitud 4000 pies, temperatura 300 °F, presión -40" C.A. El factor de corrección es 1.84 (1.16x1.43x1.11).

FACTORES DE CORRECCIÓN

TABLA 1
FACTORES DE CORRECCIÓN
POR ALTITUD

Alt. (pies)	Factor	Alt. (pies)	Factor
0	1.00	5000	1.20
500	1.02	5500	1.22
1000	1.04	6000	1.25
1500	1.06	6500	1.27
2000	1.08	7000	1.30
2500	1.10	7500	1.32
3000	1.12	8000	1.35
3500	1.14	8500	1.37
4000	1.16	9000	1.40
4500	1.18	10000	1.45

TABLA 2:
FACTORES DE CORRECCION POR
TEMPERATURA

Temp. °F	Factor	Temp. °F	Factor	Temp. °F	Factor
-50	.77	80	1.02	250	1.34
-25	.82	100	1.05	300	1.43
0	.87	120	1.09	350	1.53
20	.91	140	1.13	400	1.62
40	.94	160	1.17	50	1.72
60	.98	180	1.21	500	1.81
70	1.00	200	1.25	600	2.00

TABLA 3:
FACTORES DE CORRECCION
POR PRESIÓN NEGATIVA

"WG	Factor	"WG	Factor
15	1.04	55	1.16
20	1.05	60	1.17
25	1.07	65	1.19
30	1.08	70	1.21
35	1.09	75	1.23
40	1.11	80	1.25
45	1.12	85	1.26
50	1.14		

**FACTORES DE CORRECCIÓN PARA
EL CABALLAJE DE UN ROTOR DE
ACERO AL CARBÓN E INOXIDABLE**

EJEMPLO	Tamaño descarga	Tamaño Rotor	Factor
Tamaño 08, tamaño de descarga 0, 400 CFM 23.5"PE a 0.75 lbs/ft ³ al carbón o inoxidable (1.15x2.6) 3.0 BHP	03	12 a 22 23 a 26	0.96 1.02
	04	14 a 26	1.15
	06	14 a 18 19 a 26	1.06 1.15
	08	15 a 22 23 a 26	1.06 1.15
	10	19 a 26	1.06
	12	23 a 26	1.06

MAXIMA VELOCIDAD SEGURA

PARA ROTORES CON DIAMETRO AL 100%

Tamaño	Arr. 1, 4 y 8	Arr. 10	Tamaño	Arr. 1, 4 y 8	Arr. 10
14	4000	4000	21	3900	2851
15	4000	4000	22	3900	2787
16	4000	4000	23	3800	3178
17	4000	4000	24	3800	3121
19	4000	4000	25	3800	3068
18	3900	2992	26	3800	3017
20	3900	2918			

PESO DEL ROTOR E INERCIA (WR²=LBS.-PIE²)

Tamaño	Aluminio		Acero al carbón		Tamaño	Aluminio		Acero al carbón	
	peso [lbs]	WR ²	peso [lbs]	WR ²		peso [lbs]	WR ²	peso [lbs]	WR ²
1404	7.5	1.43	18.0	3.04	2104, 2106	12.5	4.74	32.5	12.33
1406	11.7	2.4	20.5	3.46	2108, 2110	15.5	5.3	38.0	14.42
1504	8.75	1.69	19.0	3.68	2204, 2206	12.75	5.31	34.0	14.16
1506,1508	11.8	2.4	21.5	4.16	2208, 2210	15.6	5.4	40.0	16.66
1604	9.0	1.98	20.0	4.41	2306, 2308	18.5	8.42	46.0	20.93
1606,1608	12.1	2.5	23.0	5.07	2310, 2312	21.7	10.6	53.5	24.35
1704	9.25	2.3	21.0	5.22	2406, 2408	18.75	9.29	48.0	23.79
1706,1708	12.2	2.6	24.5	6.09	2410, 2412	21.9	10.8	56.0	27.75
1804	9.5	2.65	22.0	6.3	2506, 2508	19.0	10.22	50.0	26.89
1806, 1808	12.4	2.6	26.0	7.25	2510, 2512	21.9	11.0	58.5	31.46
1904, 1906	12.0	3.73	29.5	9.16	2606, 2608	19.25	11.2	52.0	30.24
1908, 1910	15.1	5.1	34.5	10.72	2610, 2612	22.3	11.2	61.0	35.48
2004, 2006	12.25	4.22	31.0	10.67					
2008, 2010	15.3	5.2	36.5	12.56					

Solicita:

>Manual de Instalacion y Mantenimiento.

>Dibujo Certificado. >CD Selector.

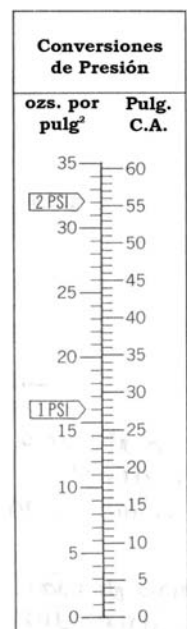



EVISA Modelo TURH-TURA Arr. 1 y 10

Tamaño	CFM	VS	8"PE		9"PE		10"PE		11"PE		12"PE		13"PE		14"PE		15"PE		16"PE		17"PE		18"PE	
			RPM	BHP	RPM	BHP	RPM	BHP	RPM	BHP	RPM	BHP	RPM	BHP	RPM	BHP	RPM	BHP	RPM	BHP	RPM	BHP	RPM	BHP
414 MAX RPM 4000	200	2222	2451	0.58	2590	0.67	2722	0.75	2849	0.85	2969	0.94	3085	1.03	3197	1.13	3306	1.23	3410	1.33	3512	1.43	3611	1.53
	240	2667	2485	0.67	2622	0.76	2753	0.86	2878	0.95	2997	1.05	3112	1.16	3223	1.26	3331	1.37	3435	1.48	3535	1.59	3633	1.7
	280	3111	2525	0.76	2660	0.86	2789	0.97	2912	1.07	3031	1.18	3144	1.29	3254	1.4	3360	1.52	3463	1.64	3563	1.75	3661	1.88
	320	3556	2572	0.87	2705	0.98	2831	1.09	2952	1.2	3069	1.32	3181	1.44	3289	1.56	3394	1.68	3496	1.8	3595	1.93	3692	2.06
	340	3778	2599	0.92	2729	1.04	2854	1.15	2974	1.27	3090	1.39	3201	1.51	3309	1.64	3413	1.76	3514	1.89	3613	2.02	3709	2.16
	360	4000	2626	0.98	2755	1.1	2879	1.22	2998	1.34	3112	1.46	3222	1.59	3329	1.72	3433	1.85	3534	1.98	3632	2.12	3727	2.25
	400	4444	2687	1.11	2812	1.24	2933	1.36	3049	1.49	3161	1.63	3269	1.76	3374	1.9	3476	2.03	3576	2.18	3672	2.32	3766	2.46
	440	4889	2753	1.25	2875	1.39	2993	1.52	3106	1.66	3215	1.8	3321	1.94	3424	2.09	3525	2.23	3622	2.38	3717	2.53	3810	2.69
	460	5111	2788	1.33	2909	1.47	3025	1.61	3136	1.75	3245	1.9	3350	2.04	3451	2.19	3551	2.34	3647	2.49	3742	2.65	3834	2.8
	480	5333	2824	1.41	2943	1.55	3058	1.7	3168	1.84	3275	1.99	3379	2.14	3480	2.3	3578	2.45	3674	2.61	3767	2.76	3858	2.92
	520	5778	2899	1.58	3016	1.74	3128	1.89	3235	2.04	3340	2.2	3441	2.36	3540	2.52	3636	2.68	3730	2.85	3822	3.01	3911	3.18
	540	6000	2937	1.67	3053	1.83	3164	1.99	3271	2.15	3374	2.31	3474	2.47	3572	2.64	3667	2.81	3760	2.97	3851	3.14	3939	3.32
	560	6222	2975	1.76	3091	1.93	3201	2.09	3307	2.26	3409	2.43	3508	2.59	3605	2.76	3699	2.93	3791	3.11	3881	3.28	3969	3.46
600	6667	3052	1.95	3167	2.13	3276	2.31	3381	2.49	3481	2.67	3579	2.85	3673	3.02	3766	3.2	3856	3.39	3944	3.57			

Tamaño	CFM	VS	12"PE		13"PE		14"PE		15"PE		16"PE		17"PE		18"PE		19"PE		20"PE		21"PE		22"PE	
			RPM	BHP	RPM	BHP	RPM	BHP	RPM	BHP	RPM	BHP	RPM	BHP	RPM	BHP	RPM	BHP	RPM	BHP	RPM	BHP	RPM	BHP
415 MAX RPM 4000	200	2222	2793	0.88	2904	0.97	3011	1.06	3115	1.15	3215	1.25	3313	1.34	3407	1.44	3500	1.54	3589	1.64	3677	1.74	3763	1.85
	240	2667	2809	0.99	2919	1.09	3025	1.19	3128	1.29	3228	1.39	3324	1.49	3418	1.6	3510	1.7	3599	1.81	3686	1.92	3771	2.03
	280	3111	2831	1.11	2939	1.21	3044	1.32	3146	1.43	3245	1.54	3341	1.65	3434	1.76	3525	1.88	3613	1.99	3700	2.11	3784	2.23
	320	3556	2859	1.23	2965	1.34	3069	1.46	3169	1.57	3266	1.69	3361	1.81	3453	1.93	3543	2.05	3631	2.18	3717	2.31	3801	2.43
	340	3778	2875	1.3	2981	1.42	3083	1.53	3183	1.65	3279	1.77	3373	1.9	3465	2.02	3554	2.15	3642	2.28	3727	2.41	3811	2.54
	360	4000	2894	1.37	2998	1.49	3099	1.61	3198	1.73	3293	1.86	3387	1.98	3478	2.11	3567	2.24	3653	2.37	3738	2.51	3821	2.64
	400	4444	2936	1.52	3038	1.65	3136	1.77	3233	1.91	3326	2.04	3418	2.17	3507	2.31	3595	2.44	3680	2.58	3764	2.72	3846	2.87
	440	4889	2986	1.69	3085	1.82	3181	1.96	3274	2.09	3366	2.23	3455	2.37	3543	2.51	3629	2.66	3713	2.8	3795	2.95	3876	3.1
	460	5111	3014	1.79	3111	1.92	3205	2.06	3298	2.2	3388	2.34	3476	2.48	3563	2.62	3648	2.77	3731	2.92	3812	3.07	3892	3.22
	480	5333	3043	1.88	3139	2.02	3232	2.16	3323	2.3	3412	2.45	3499	2.59	3585	2.74	3668	2.89	3751	3.04	3831	3.2	3911	3.35
	520	5778	3106	2.09	3199	2.23	3289	2.38	3378	2.53	3464	2.68	3549	2.83	3633	2.99	3714	3.14	3795	3.3	3873	3.46	3951	3.63
	540	6000	3139	2.2	3231	2.35	3320	2.5	3407	2.65	3493	2.8	3577	2.96	3659	3.12	3739	3.28	3819	3.44	3897	3.6	3973	3.77
	560	6222	3173	2.31	3264	2.47	3352	2.62	3438	2.78	3523	2.94	3605	3.09	3686	3.25	3766	3.42	3844	3.58	3921	3.75	3997	3.92
600	6667	3243	2.56	3332	2.72	3419	2.88	3503	3.05	3586	3.21	3666	3.38	3745	3.55	3823	3.72	3900	3.89	3975	4.06			

Tamaño	CFM	VS	14"PE		15"PE		16"PE		17"PE		18"PE		19"PE		20"PE		21"PE		22"PE		23"PE		24"PE	
			RPM	BHP	RPM	BHP	RPM	BHP	RPM	BHP	RPM	BHP	RPM	BHP	RPM	BHP	RPM	BHP	RPM	BHP	RPM	BHP	RPM	BHP
416 MAX RPM 4000	200	2222	2888	1.02	2988	1.1	3086	1.2	3181	1.29	3273	1.38	3363	1.48	3451	1.57	3536	1.67	3620	1.77	3702	1.87	3783	1.97
	240	2667	2896	1.14	2995	1.23	3092	1.33	3185	1.43	3276	1.53	3365	1.63	3451	1.74	3536	1.84	3619	1.95	3700	2.06	3779	2.17
	280	3111	2912	1.26	3010	1.37	3104	1.47	3197	1.58	3287	1.69	3374	1.8	3460	1.91	3543	2.02	3625	2.14	3705	2.25	3783	2.37
	320	3556	2934	1.4	3030	1.51	3123	1.62	3214	1.74	3303	1.85	3389	1.97	3474	2.09	3556	2.21	3637	2.33	3716	2.45	3794	2.58
	340	3778	2947	1.48	3042	1.59	3135	1.7	3225	1.82	3313	1.94	3399	2.06	3483	2.18	3565	2.31	3645	2.43	3724	2.56	3801	2.69
	360	4000	2962	1.55	3056	1.67	3148	1.79	3237	1.91	3325	2.03	3410	2.15	3493	2.28	3575	2.41	3654	2.53	3733	2.67	3809	2.8
	400	4444	2996	1.72	3088	1.84	3178	1.96	3266	2.09	3352	2.22	3436	2.35	3518	2.48	3598	2.62	3677	2.75	3754	2.89	3830	3.03
	440	4889	3036	1.9	3127	2.03	3215	2.16	3300	2.29	3385	2.43	3467	2.57	3547	2.7	3626	2.84	3704	2.99	3780	3.13	3855	3.28
	460	5111	3059	1.99	3148	2.13	3235	2.26	3320	2.4	3403	2.54	3484	2.68	3564	2.82	3643	2.97	3719	3.11	3795	3.26	3869	3.41
	480	5333	3083	2.09	3171	2.23	3257	2.37	3341	2.51	3423	2.65	3503	2.8	3582	2.94	3660	3.09	3736	3.24	3811	3.39	3884	3.54
	520	5778	3135	2.31	3221	2.45	3304	2.6	3386	2.75	3467	2.9	3545	3.05	3623	3.2	3699	3.35	3773	3.51	3847	3.67	3919	3.83
	540	6000	3163	2.42	3248	2.57	3330	2.72	3411	2.87	3491	3.03	3568	3.18	3645	3.34	3720	3.49	3794	3.65	3866	3.81	3938	3.97
	560	6222	3192	2.54	3276	2.69	3357	2.85	3437	3	3516	3.16	3593	3.32	3668	3.48	3742	3.64	3816	3.8	3887	3.96	3958	4.13
600	6667	3254	2.79	3335	2.95	3415	3.11	3493	3.28	3569	3.44	3645	3.61	3718	3.77	3791	3.94	3863	4.11	3933	4.28			

Tamaño	CFM	VS	15"PE		18"PE		20"PE		21"PE		22"PE		23"PE		24"PE		25"PE		26"PE		27"PE		28"PE	
			RPM	BHP	RPM	BHP	RPM	BHP	RPM	BHP	RPM	BHP	RPM	BHP	RPM	BHP	RPM	BHP	RPM	BHP	RPM	BHP	RPM	BHP
417 MAX RPM 4000	200	2222	2866	0.97	3142	1.2	3314	1.36	3397	1.44	3479	1.53	3559	1.61	3637	1.7	3714	1.78	3789	1.87	3864	1.95	3937	2.04
	240	2667	2869	1.1	3140	1.36	3309	1.53	3391	1.62	3471	1.71	3549	1.8	3626	1.9	3702	1.99	3776	2.09	3849	2.18	3920	2.28
	280	3111	2880	1.24	3147	1.52	3314	1.71	3394	1.81	3473	1.9	3550	2	3626	2.1	3700	2.2	3773	2.31	3845	2.41	3916	2.52
	320	3556	2895	1.39	3159	1.69	3324	1.89	3404	2	3482	2.1	3558	2.21	3633	2.32	3706	2.43	3778	2.54	3849	2.65	3919	2.76
	340	3778	2905	1.46	3167	1.78	3331	1.99	3410	2.1	3488	2.21	3564	2.32	3638	2.43	3711	2.54	3783	2.65	3853	2.77	3923	2.89
	360	4000	2916	1.54	3176	1.87	3339	2.09	3418	2.2	3495	2.31	3570	2.43	3645	2.54	3717	2.66	3789	2.78	3859	2.89	3928	3.01
	400	4444	2941	1.71	3197	2.06	3358	2.29	3436															



EVISA Modelo TURH-TURA Arr. 1 y 10

Tamaño	CFM	VS	16"PE		18"PE		20"PE		21"PE		22"PE		23"PE		24"PE		25"PE		26"PE		28"PE		30"PE	
			RPM	BHP	RPM	BHP	RPM	BHP	RPM	BHP	RPM	BHP	RPM	BHP	RPM	BHP	RPM	BHP	RPM	BHP	RPM	BHP	RPM	BHP
418 MAX RPM 4000	200	2222	2862	1.19	3038	1.37	3205	1.56	3286	1.66	3365	1.76	3443	1.86	3519	1.96	3593	2.06	3666	2.16	3809	2.38	3947	2.59
	240	2667	2860	1.33	3033	1.53	3198	1.73	3277	1.84	3355	1.94	3431	2.05	3506	2.16	3579	2.27	3651	2.38	3792	2.61	3927	2.84
	280	3111	2865	1.47	3035	1.69	3198	1.91	3276	2.02	3353	2.13	3428	2.25	3502	2.37	3574	2.48	3645	2.6	3784	2.85	3918	3.1
	320	3556	2876	1.62	3044	1.85	3204	2.09	3282	2.21	3358	2.33	3432	2.45	3505	2.58	3576	2.7	3646	2.83	3783	3.09	3915	3.35
	340	3778	2883	1.7	3051	1.94	3210	2.18	3287	2.31	3362	2.43	3436	2.56	3508	2.69	3579	2.82	3649	2.95	3785	3.21	3916	3.48
	360	4000	2892	1.79	3058	2.03	3216	2.28	3292	2.41	3367	2.54	3441	2.67	3512	2.8	3583	2.93	3652	3.07	3788	3.34	3918	3.62
	400	4444	2914	1.96	3077	2.22	3233	2.48	3308	2.62	3382	2.76	3454	2.89	3525	3.03	3595	3.17	3663	3.31	3797	3.6	3926	3.89
	440	4889	2942	2.15	3101	2.42	3254	2.7	3328	2.84	3401	2.99	3472	3.13	3542	3.28	3611	3.42	3678	3.57	3810	3.87	3938	4.18
	460	5111	2957	2.25	3115	2.53	3266	2.81	3340	2.96	3412	3.11	3482	3.25	3552	3.4	3620	3.55	3687	3.71	3819	4.02	3946	4.33
	480	5333	2974	2.35	3130	2.64	3280	2.93	3353	3.08	3424	3.23	3494	3.38	3563	3.53	3631	3.69	3698	3.85	3828	4.16	3954	4.48
	520	5778	3013	2.57	3165	2.87	3311	3.18	3382	3.33	3452	3.49	3521	3.65	3589	3.81	3655	3.97	3721	4.14	3849	4.46	3974	4.8
	540	6000	3034	2.69	3184	2.99	3329	3.31	3399	3.47	3468	3.63	3536	3.79	3603	3.95	3669	4.12	3734	4.29	3862	4.62	3986	4.97
560	6222	3057	2.81	3205	3.12	3347	3.44	3417	3.61	3485	3.77	3553	3.94	3619	4.1	3684	4.27	3749	4.44	3875	4.79	3998	5.14	
600	6667	3105	3.06	3249	3.39	3388	3.73	3456	3.9	3523	4.07	3589	4.24	3654	4.42	3718	4.59	3781	4.77	3905	5.13			

Tamaño	CFM	VS	25"PE		26"PE		27"PE		28"PE		29"PE		30"PE		31"PE		32"PE		33"PE		34"PE		35"PE	
			RPM	BHP	RPM	BHP	RPM	BHP	RPM	BHP	RPM	BHP	RPM	BHP	RPM	BHP	RPM	BHP	RPM	BHP	RPM	BHP	RPM	BHP
419 MAX RPM 3900	200	2222	3255	2.17	3320	2.28	3384	2.4	3446	2.51	3508	2.63	3569	2.75	3629	2.87	3687	2.99	3745	3.11	3802	3.24	3858	3.36
	240	2667	3250	2.35	3314	2.47	3378	2.59	3440	2.72	3502	2.84	3562	2.97	3622	3.1	3680	3.22	3738	3.35	3794	3.48	3850	3.62
	280	3111	3249	2.54	3313	2.67	3376	2.8	3438	2.92	3499	3.06	3559	3.19	3618	3.32	3676	3.46	3733	3.59	3790	3.73	3845	3.87
	320	3556	3252	2.74	3316	2.87	3378	3	3440	3.14	3500	3.28	3560	3.42	3618	3.56	3676	3.7	3733	3.84	3789	3.99	3844	4.13
	340	3778	3256	2.84	3319	2.98	3381	3.11	3442	3.25	3502	3.39	3561	3.54	3620	3.68	3677	3.82	3734	3.97	3790	4.12	3845	4.27
	360	4000	3260	2.95	3323	3.09	3385	3.23	3446	3.37	3505	3.51	3564	3.66	3622	3.8	3679	3.95	3736	4.1	3791	4.25	3846	4.41
	400	4444	3272	3.17	3334	3.32	3395	3.46	3456	3.61	3515	3.76	3573	3.91	3630	4.06	3687	4.22	3743	4.38	3798	4.53	3852	4.69
	440	4889	3289	3.41	3350	3.56	3410	3.72	3469	3.87	3528	4.03	3585	4.18	3642	4.34	3698	4.5	3753	4.66	3808	4.83	3861	4.99
	460	5111	3298	3.54	3359	3.69	3419	3.85	3478	4.01	3536	4.16	3593	4.32	3649	4.49	3705	4.65	3760	4.82	3814	4.98	3867	5.15
	480	5333	3309	3.67	3370	3.83	3429	3.99	3487	4.15	3545	4.31	3602	4.47	3658	4.64	3713	4.8	3768	4.97	3821	5.14	3874	5.31
	520	5778	3333	3.94	3393	4.11	3451	4.27	3509	4.44	3566	4.61	3622	4.78	3677	4.95	3732	5.12	3785	5.29	3839	5.47	3891	5.65
	540	6000	3347	4.09	3406	4.26	3464	4.42	3521	4.59	3578	4.77	3633	4.94	3688	5.11	3742	5.29	3796	5.47	3849	5.65		
560	6222	3361	4.24	3420	4.41	3477	4.58	3534	4.75	3590	4.93	3645	5.1	3700	5.28	3754	5.46	3807	5.64	3859	5.82			
600	6667	3392	4.55	3450	4.72	3507	4.9	3563	5.08	3618	5.27	3672	5.45	3726	5.63	3779	5.82	3832	6.01	3883	6.19			

Tamaño	CFM	VS	28"PE		29"PE		30"PE		31"PE		32"PE		33"PE		34"PE		35"PE		36"PE		37"PE		38"PE	
			RPM	BHP	RPM	BHP	RPM	BHP	RPM	BHP	RPM	BHP	RPM	BHP	RPM	BHP	RPM	BHP	RPM	BHP	RPM	BHP	RPM	BHP
420 MAX RPM 3900	200	2222	3317	2.36	3377	2.46	3437	2.57	3495	2.68	3553	2.79	3609	2.9	3665	3.01	3720	3.12	3775	3.23	3828	3.35	3881	3.46
	240	2667	3303	2.58	3363	2.7	3421	2.81	3479	2.93	3536	3.05	3592	3.17	3647	3.29	3702	3.41	3756	3.53	3809	3.66	3861	3.78
	280	3111	3296	2.81	3355	2.93	3413	3.06	3470	3.18	3526	3.31	3582	3.44	3636	3.56	3690	3.69	3743	3.82	3796	3.96	3848	4.09
	320	3556	3294	3.04	3352	3.17	3410	3.3	3466	3.43	3522	3.57	3577	3.7	3631	3.84	3684	3.98	3737	4.12	3789	4.25	3840	4.39
	340	3778	3295	3.15	3353	3.29	3410	3.42	3466	3.56	3521	3.7	3576	3.84	3630	3.98	3683	4.12	3735	4.26	3787	4.4	3838	4.55
	360	4000	3298	3.27	3355	3.41	3412	3.55	3467	3.69	3522	3.83	3577	3.97	3630	4.11	3683	4.26	3735	4.41	3787	4.56	3837	4.7
	400	4444	3306	3.51	3362	3.66	3418	3.8	3473	3.95	3528	4.1	3581	4.25	3634	4.4	3686	4.55	3738	4.71	3789	4.86	3839	5.01
	440	4889	3318	3.77	3374	3.92	3429	4.07	3484	4.23	3537	4.38	3590	4.54	3642	4.69	3694	4.85	3745	5.01	3795	5.17	3845	5.34
	460	5111	3325	3.9	3381	4.05	3436	4.21	3490	4.37	3543	4.52	3596	4.68	3648	4.85	3699	5.01	3750	5.17	3800	5.34	3849	5.5
	480	5333	3334	4.03	3389	4.19	3443	4.35	3497	4.51	3550	4.67	3603	4.84	3654	5	3705	5.16	3756	5.33	3805	5.5	3855	5.67
	520	5778	3353	4.31	3407	4.48	3461	4.64	3514	4.81	3567	4.98	3618	5.15	3670	5.32	3720	5.49	3770	5.67	3819	5.84	3868	6.02
	540	6000	3363	4.46	3418	4.63	3471	4.8	3524	4.97	3576	5.14	3628	5.31	3678	5.49	3728	5.66	3778	5.84	3827	6.02	3875	6.2
560	6222	3375	4.61	3429	4.78	3482	4.95	3534	5.13	3586	5.3	3637	5.48	3688	5.66	3738	5.84	3787	6.02	3836	6.2	3884	6.38	
600	6667	3400	4.93	3453	5.1	3505	5.28	3557	5.46	3608	5.64	3659	5.83	3709	6.01	3758	6.2	3807	6.39	3855	6.57			

Tamaño	CFM	VS	31"PE		32"PE		33"PE		34"PE		35"PE		36"PE		37"PE		38"PE		39"PE		40"PE		41"PE			
			RPM	BHP	RPM	BHP	RPM	BHP	RPM	BHP	RPM	BHP	RPM	BHP	RPM	BHP	RPM	BHP	RPM	BHP	RPM	BHP	RPM	BHP	RPM	BHP
421 MAX RPM 3900	200	2222	3408	2.84	3463	2.96	3518	3.08	3572	3.2	3626	3.32	3678	3.45	3730	3.57	3781	3.69	3832	3.82	3882	3.95				
	240	2667	3395																							



EVISA Modelo TURH-TURA Arr. 1 y 10

Tamaño	CFM	VS	35"PE		36"PE		37"PE		38"PE		39"PE		40"PE		41"PE		42"PE		43"PE		44"PE		45"PE		
			RPM	BHP	RPM	BHP	RPM	BHP	RPM	BHP	RPM	BHP	RPM	BHP	RPM	BHP	RPM	BHP	RPM	BHP	RPM	BHP	RPM	BHP	RPM
422 MAX RPM 3900	200	2222	3569	3.22	3621	3.34	3673	3.46	3723	3.58	3773	3.7	3822	3.82	3871	3.94									
	240	2667	3550	3.5	3602	3.63	3653	3.76	3703	3.88	3753	4.01	3803	4.14	3851	4.27	3900	4.41							
	280	3111	3531	3.79	3583	3.93	3634	4.06	3684	4.2	3734	4.34	3784	4.48	3832	4.61	3880	4.75							
	320	3556	3515	4.09	3566	4.23	3617	4.37	3667	4.52	3717	4.66	3766	4.81	3814	4.96	3862	5.1							
	340	3778	3508	4.24	3559	4.39	3610	4.53	3660	4.68	3709	4.83	3758	4.98	3806	5.13	3854	5.28							
	360	4000	3501	4.39	3553	4.54	3603	4.69	3653	4.84	3702	5	3751	5.15	3799	5.3	3847	5.46	3894	5.62					
	400	4444	3492	4.7	3542	4.85	3592	5.01	3642	5.17	3691	5.34	3739	5.5	3787	5.66	3834	5.82	3881	5.99					
	440	4889	3486	5.01	3536	5.18	3586	5.34	3635	5.51	3683	5.68	3731	5.85	3778	6.02	3825	6.19	3871	6.37					
	460	5111	3485	5.17	3535	5.34	3584	5.51	3633	5.68	3681	5.86	3728	6.03	3775	6.2	3822	6.38	3868	6.56					
	480	5333	3485	5.33	3535	5.51	3583	5.68	3632	5.86	3679	6.03	3726	6.21	3773	6.39	3819	6.57	3865	6.75					
	520	5778	3489	5.67	3537	5.85	3585	6.03	3633	6.22	3680	6.4	3726	6.58	3772	6.77	3818	6.96	3863	7.15					
	540	6000	3492	5.84	3540	6.03	3588	6.21	3635	6.4	3681	6.58	3728	6.78	3773	6.96	3819	7.16	3863	7.34					
	560	6222	3496	6.02	3544	6.21	3591	6.39	3638	6.58	3684	6.77	3730	6.97	3775	7.16	3820	7.35	3865	7.55					
600	6667	3508	6.38	3555	6.57	3601	6.77	3647	6.97	3693	7.17	3738	7.37	3782	7.56	3827	7.77	3871	7.97						

Tamaño	CFM	VS	9"PE		10"PE		11"PE		12"PE		13"PE		14"PE		15"PE		16"PE		17"PE		17 1/2"PE		18"PE	
			RPM	BHP	RPM	BHP	RPM	BHP	RPM	BHP	RPM	BHP	RPM	BHP	RPM	BHP	RPM	BHP	RPM	BHP	RPM	BHP	RPM	BHP
614 MAX RPM 4000	500	2500	2662	1.19	2794	1.33	2921	1.47	3042	1.61	3160	1.76	3273	1.91	3383	2.07	3490	2.23	3594	2.38	3645	2.46	3696	2.55
	550	2750	2686	1.3	2817	1.44	2942	1.6	3062	1.75	3178	1.91	3290	2.07	3398	2.23	3504	2.39	3607	2.56	3657	2.64	3707	2.73
	600	3000	2713	1.41	2842	1.57	2966	1.73	3084	1.89	3199	2.06	3310	2.22	3417	2.39	3521	2.57	3623	2.74	3673	2.83	3722	2.92
	650	3250	2741	1.54	2869	1.7	2992	1.87	3109	2.04	3223	2.21	3332	2.39	3439	2.57	3542	2.75	3642	2.93	3692	3.02	3740	3.12
	700	3500	2771	1.67	2898	1.84	3020	2.02	3136	2.2	3249	2.38	3357	2.56	3463	2.75	3565	2.94	3664	3.13	3713	3.23	3761	3.32
	750	3750	2802	1.81	2928	1.99	3049	2.18	3165	2.37	3276	2.55	3384	2.75	3489	2.94	3590	3.14	3689	3.34	3737	3.44	3785	3.54
	800	4000	2834	1.96	2959	2.15	3079	2.34	3195	2.54	3305	2.74	3413	2.95	3516	3.14	3617	3.35	3715	3.56	3763	3.66	3810	3.77
	850	4250	2868	2.12	2992	2.32	3111	2.52	3225	2.72	3336	2.93	3442	3.14	3545	3.35	3645	3.57	3743	3.79	3790	3.89	3837	4
	900	4500	2903	2.28	3025	2.49	3143	2.7	3257	2.92	3367	3.14	3472	3.35	3575	3.58	3675	3.8	3771	4.02	3819	4.14	3865	4.25
	950	4750	2940	2.46	3061	2.68	3177	2.9	3290	3.12	3399	3.35	3504	3.58	3606	3.81	3705	4.04	3801	4.27	3848	4.39	3895	4.51
	1000	5000	2980	2.64	3098	2.87	3213	3.1	3324	3.34	3432	3.57	3536	3.81	3638	4.05	3736	4.29	3832	4.53	3879	4.66	3925	4.78
	1050	5250	3023	2.84	3138	3.08	3250	3.32	3360	3.56	3466	3.8	3570	4.05	3670	4.3	3768	4.55	3863	4.8	3910	4.93	3956	5.06
	1100	5500	3070	3.05	3181	3.29	3290	3.54	3397	3.79	3502	4.05	3604	4.31	3704	4.56	3801	4.82	3895	5.08	3942	5.22	3988	5.35
1200	6000	3176	3.51	3277	3.77	3379	4.03	3480	4.3	3580	4.57	3679	4.85	3776	5.13	3870	5.4	3963	5.69					

Tamaño	CFM	VS	13"PE		14"PE		15"PE		16"PE		17"PE		18"PE		19"PE		20"PE		20 1/2"PE		21"PE		22"PE	
			RPM	BHP	RPM	BHP	RPM	BHP	RPM	BHP	RPM	BHP	RPM	BHP	RPM	BHP	RPM	BHP	RPM	BHP	RPM	BHP	RPM	BHP
615 MAX RPM 4000	500	2500	2939	1.73	3047	1.88	3152	2.03	3253	2.18	3351	2.34	3447	2.5	3541	2.66	3632	2.82	3677	2.91	3721	2.99	3809	3.16
	550	2750	2949	1.87	3056	2.02	3159	2.18	3260	2.34	3357	2.51	3453	2.68	3545	2.84	3636	3.01	3680	3.1	3724	3.19	3811	3.36
	600	3000	2962	2.01	3067	2.18	3170	2.34	3269	2.51	3366	2.68	3460	2.86	3552	3.04	3642	3.21	3686	3.3	3730	3.4	3816	3.58
	650	3250	2977	2.16	3082	2.34	3183	2.51	3281	2.69	3377	2.87	3471	3.05	3562	3.24	3651	3.42	3695	3.52	3738	3.61	3823	3.8
	700	3500	2995	2.32	3098	2.5	3199	2.69	3296	2.87	3391	3.06	3483	3.25	3574	3.45	3662	3.64	3705	3.74	3748	3.84	3833	4.03
	750	3750	3016	2.49	3118	2.68	3217	2.87	3313	3.07	3407	3.26	3498	3.46	3588	3.66	3675	3.86	3718	3.97	3761	4.07	3845	4.28
	800	4000	3039	2.67	3140	2.87	3237	3.06	3332	3.27	3425	3.47	3515	3.68	3604	3.89	3690	4.1	3733	4.2	3775	4.31	3858	4.52
	850	4250	3065	2.85	3164	3.06	3260	3.27	3354	3.48	3445	3.69	3535	3.91	3622	4.12	3708	4.34	3750	4.45	3792	4.56	3874	4.78
	900	4500	3094	3.05	3191	3.26	3285	3.48	3378	3.7	3468	3.92	3557	4.14	3643	4.37	3728	4.6	3769	4.71	3811	4.82	3892	5.05
	950	4750	3124	3.25	3220	3.47	3313	3.7	3404	3.92	3493	4.15	3581	4.39	3666	4.62	3750	4.86	3791	4.98	3832	5.1	3912	5.33
	1000	5000	3157	3.46	3251	3.69	3343	3.93	3433	4.17	3521	4.4	3607	4.64	3691	4.89	3773	5.13	3814	5.25	3855	5.38	3934	5.62
	1050	5250	3192	3.69	3284	3.93	3375	4.17	3463	4.41	3550	4.66	3635	4.91	3718	5.16	3799	5.41	3840	5.54	3880	5.67	3958	5.93
	1100	5500	3228	3.92	3319	4.17	3409	4.42	3496	4.68	3581	4.93	3665	5.19	3747	5.45	3827	5.71	3867	5.84	3906	5.97	3984	6.24
1200	6000	3305	4.43	3394	4.7	3481	4.97	3566	5.24	3649	5.51	3730	5.78	3810	6.06	3889	6.34	3927	6.48	3966	6.62			

Tamaño	CFM	VS	16"PE		17"PE		18"PE		19"PE		20"PE		21"PE		22"PE		23"PE		24"PE		25"PE		26"PE	
			RPM	BHP	RPM	BHP	RPM	BHP	RPM	BHP	RPM	BHP	RPM	BHP	RPM	BHP	RPM	BHP	RPM	BHP	RPM	BHP	RPM	BHP
616 MAX RPM 4000	500	2500	3055	2.12	3149	2.27	3239	2.43	3328	2.58	3414	2.74	3499	2.9	3581	3.07	3662	3.23	3742	3.4	3819	3.57	3896	3.74
	550	2750	3060	2.28	3152	2.44	3242	2.6	3330	2.76	3416	2.93	3499	3.1	3581	3.27	3661	3.44	3740	3.61	3817	3.79	3893	3.97
	600	3000																						



EVISA Modelo TURH-TURA Arr. 1 y 10

Tamaño	CFM	VS	16"PE		18"PE		20"PE		22"PE		23"PE		24"PE		25"PE		26"PE		27"PE		28"PE		29"PE	
			RPM	BHP	RPM	BHP	RPM	BHP	RPM	BHP	RPM	BHP	RPM	BHP	RPM	BHP	RPM	BHP	RPM	BHP	RPM	BHP	RPM	BHP
617 MAX RPM 4000	500	2500	2926	2.12	3106	2.42	3277	2.73	3441	3.06	3520	3.22	3598	3.38	3675	3.55	3750	3.72	3823	3.89	3896	4.06	3967	4.23
	550	2750	2925	2.27	3102	2.59	3272	2.92	3434	3.26	3512	3.43	3589	3.6	3665	3.78	3739	3.95	3813	4.14	3884	4.31	3955	4.49
	600	3000	2928	2.43	3103	2.77	3270	3.12	3430	3.47	3508	3.65	3584	3.83	3659	4.01	3733	4.2	3805	4.38	3876	4.57	3946	4.76
	650	3250	2935	2.6	3107	2.96	3272	3.32	3430	3.69	3507	3.87	3582	4.06	3656	4.25	3729	4.45	3801	4.64	3871	4.84	3941	5.04
	700	3500	2945	2.78	3115	3.15	3277	3.52	3433	3.91	3509	4.1	3584	4.3	3657	4.5	3729	4.7	3800	4.91	3869	5.11	3938	5.31
	750	3750	2958	2.96	3126	3.35	3286	3.74	3440	4.14	3515	4.35	3588	4.55	3660	4.75	3732	4.97	3802	5.18	3870	5.39	3938	5.6
	800	4000	2974	3.16	3139	3.56	3297	3.96	3449	4.38	3523	4.59	3596	4.81	3667	5.02	3737	5.24	3806	5.45	3874	5.67	3942	5.9
	850	4250	2992	3.36	3155	3.77	3311	4.2	3461	4.63	3534	4.85	3606	5.07	3676	5.29	3746	5.52	3814	5.74	3881	5.97	3948	6.2
	900	4500	3012	3.57	3173	4	3327	4.44	3475	4.89	3547	5.11	3618	5.34	3688	5.57	3756	5.8	3824	6.04	3891	6.28	3956	6.51
	950	4750	3034	3.79	3193	4.24	3345	4.69	3492	5.16	3563	5.39	3633	5.63	3702	5.87	3770	6.11	3836	6.35	3902	6.59	3967	6.84
	1000	5000	3058	4.02	3215	4.48	3365	4.96	3510	5.44	3580	5.68	3650	5.92	3718	6.17	3785	6.42	3851	6.67	3916	6.92	3980	7.17
	1050	5250	3083	4.26	3238	4.74	3387	5.23	3530	5.72	3600	5.98	3668	6.23	3736	6.48	3802	6.74	3867	6.99	3932	7.26	3995	7.52
1100	5500	3109	4.5	3263	5.01	3410	5.51	3552	6.03	3621	6.28	3689	6.55	3755	6.81	3821	7.07	3886	7.34	3949	7.6			
1200	6000	3165	5.03	3316	5.57	3461	6.11	3599	6.66	3667	6.93	3734	7.21	3799	7.49	3863	7.77	3927	8.06	3989	8.34			

Tamaño	CFM	VS	20"PE		22"PE		24"PE		25"PE		26"PE		27"PE		28"PE		30"PE		31"PE		32"PE		33"PE	
			RPM	BHP	RPM	BHP	RPM	BHP	RPM	BHP	RPM	BHP	RPM	BHP	RPM	BHP	RPM	BHP	RPM	BHP	RPM	BHP	RPM	BHP
618 MAX RPM 4000	500	2500	3092	2.87	3247	3.22	3395	3.57	3467	3.75	3538	3.93	3608	4.12	3676	4.3	3809	4.68	3875	4.87	3939	5.07		
	550	2750	3086	3.05	3240	3.41	3387	3.78	3458	3.97	3529	4.16	3598	4.36	3665	4.55	3798	4.94	3862	5.14	3926	5.34	3989	5.55
	600	3000	3083	3.24	3235	3.61	3381	4	3452	4.2	3522	4.4	3590	4.59	3657	4.8	3789	5.21	3853	5.41	3916	5.62	3979	5.84
	650	3250	3083	3.43	3233	3.82	3378	4.22	3448	4.43	3517	4.63	3585	4.84	3652	5.05	3782	5.48	3846	5.69	3909	5.91	3971	6.13
	700	3500	3085	3.62	3234	4.03	3377	4.45	3447	4.66	3515	4.87	3582	5.09	3649	5.31	3778	5.75	3841	5.97	3904	6.2	3965	6.43
	750	3750	3089	3.83	3237	4.25	3379	4.68	3448	4.9	3515	5.12	3582	5.35	3648	5.58	3776	6.03	3839	6.26	3900	6.49	3961	6.73
	800	4000	3095	4.03	3241	4.47	3382	4.92	3450	5.15	3518	5.38	3584	5.61	3649	5.85	3776	6.32	3838	6.56	3900	6.8	3960	7.04
	850	4250	3102	4.24	3247	4.7	3387	5.17	3455	5.41	3522	5.64	3587	5.88	3652	6.13	3778	6.61	3840	6.86	3900	7.11	3961	7.36
	900	4500	3110	4.46	3255	4.94	3393	5.42	3461	5.67	3527	5.91	3592	6.16	3656	6.41	3782	6.92	3843	7.17	3903	7.43	3963	7.69
	950	4750	3120	4.68	3263	5.17	3401	5.68	3468	5.93	3534	6.19	3599	6.44	3662	6.7	3787	7.22	3847	7.48	3907	7.75	3967	8.02
	1000	5000	3129	4.9	3273	5.42	3410	5.94	3476	6.2	3542	6.46	3606	6.73	3669	6.99	3793	7.53	3853	7.8	3913	8.08	3972	8.36
	1050	5250	3139	5.13	3282	5.66	3419	6.2	3486	6.48	3551	6.75	3615	7.02	3678	7.3	3801	7.86	3861	8.14	3920	8.42	3978	8.7
1100	5500	3149	5.36	3292	5.91	3429	6.47	3495	6.75	3560	7.04	3624	7.32	3687	7.61	3809	8.18	3869	8.47	3928	8.76	3986	9.05	
1200	6000	3165	5.8	3310	6.4	3448	7.01	3514	7.31	3580	7.62	3643	7.92	3706	8.23	3828	8.85	3887	9.15	3946	9.46			

Tamaño	CFM	VS	20"PE		21"PE		22"PE		24"PE		25"PE		26"PE		27"PE		28"PE		29"PE		30"PE		31"PE	
			RPM	BHP	RPM	BHP	RPM	BHP	RPM	BHP	RPM	BHP	RPM	BHP	RPM	BHP	RPM	BHP	RPM	BHP	RPM	BHP	RPM	BHP
619 MAX RPM 3900	500	2500	2888	2.74	2956	2.89	3022	3.04	3152	3.35	3215	3.51	3277	3.67	3338	3.83	3398	3.99	3457	4.16	3515	4.32	3572	4.49
	550	2750	2903	2.97	2970	3.13	3036	3.29	3164	3.61	3226	3.78	3287	3.94	3347	4.11	3407	4.28	3465	4.46	3522	4.63	3579	4.8
	600	3000	2923	3.21	2989	3.38	3054	3.55	3180	3.89	3241	4.06	3301	4.24	3361	4.41	3419	4.59	3477	4.77	3533	4.95	3589	5.13
	650	3250	2945	3.47	3010	3.64	3074	3.82	3199	4.18	3259	4.36	3319	4.54	3377	4.73	3435	4.91	3492	5.1	3548	5.29	3603	5.48
	700	3500	2971	3.74	3035	3.92	3098	4.11	3221	4.49	3281	4.68	3339	4.86	3397	5.06	3454	5.25	3510	5.45	3566	5.65	3620	5.84
	750	3750	2999	4.03	3062	4.22	3125	4.41	3246	4.81	3305	5.01	3363	5.2	3420	5.41	3476	5.61	3532	5.81	3586	6.02	3640	6.22
	800	4000	3030	4.33	3092	4.53	3154	4.73	3273	5.14	3331	5.35	3388	5.56	3445	5.77	3501	5.98	3555	6.19	3609	6.4	3663	6.62
	850	4250	3062	4.64	3124	4.85	3185	5.07	3302	5.49	3360	5.71	3417	5.93	3472	6.15	3527	6.37	3581	6.59	3635	6.81	3688	7.04
	900	4500	3097	4.97	3158	5.19	3218	5.42	3334	5.86	3391	6.09	3447	6.32	3502	6.54	3556	6.77	3610	7	3663	7.24	3715	7.47
	950	4750	3133	5.32	3194	5.55	3252	5.78	3368	6.25	3424	6.49	3479	6.72	3533	6.96	3587	7.2	3640	7.44	3692	7.68	3744	7.92
	1000	5000	3172	5.69	3231	5.93	3289	6.17	3403	6.65	3458	6.9	3513	7.14	3567	7.39	3620	7.64	3672	7.89	3724	8.14	3775	8.39
	1050	5250	3212	6.07	3270	6.32	3328	6.57	3440	7.08	3494	7.33	3548	7.58	3602	7.84	3654	8.1	3706	8.36	3757	8.62	3807	8.87
1100	5500	3254	6.48	3311	6.74	3368	7	3478	7.52	3532	7.78	3585	8.04	3638	8.31	3690	8.58	3741	8.84	3792	9.12	3841	9.38	
1200	6000	3342	7.36	3398	7.64	3453	7.92	3560	8.47	3613	8.75	3664	9.03	3716	9.32	3766	9.6	3816	9.89	3866	10.2			

Tamaño	CFM	VS	22"PE		24"PE		26"PE		28"PE		30"PE		31"PE		32"PE		33"PE		34"PE		35"PE		36"PE	
			RPM	BHP	RPM	BHP	RPM	BHP	RPM	BHP	RPM	BHP	RPM	BHP	RPM	BHP	RPM	BHP	RPM	BHP	RPM	BHP	RPM	BHP
620 MAX RPM 3900	500	2500	2895	3.01	3021	3.32	3143	3.64	3260	3.96	3374	4.28	3430	4.45	3484	4.62	3538	4.78	3592	4.95	3644	5.12	3696	5.29
	550	2750	2905	3.25	3029	3.57	3149	3.91	3265	4.24	3377	4.59	3432	4.76	3486	4.93	3540	5.11	3593	5.29	3645	5.47	3696	5.65
	600	3000	2918	3.5	3040	3.84	3158	4.18	3273	4.54	3384	4.9	3438	5.08	3492	5.26	3545	5.45	3597	5.63	3648	5.82	3699	6.01
	650	3250	2934	3.76	3055	4.12	3171	4.48	3284	4.85	3394	5.22	3448	5.42	3500	5.6	3553	5.8	3604	5.99	3655	6.19	3706	6.38
	700	3500	2954	4.04	3073	4.41	3188	4.79	3299	5.18	3407	5.57	3460	5.76	3512	5.96	3564	6.16	3615	6.36	3665	6.57	3715	6.77
	750	3750	2976	4.33	3093	4.72	3207	5.12	3317	5.52	3423	5.92	3476	6.13	3527	6.33	3578	6.54	3629	6.76	3678	6.96	3728	7.18
	800	4000	3001	4.65	3117	5.05																		



EVISA Modelo TURH-TURA Arr. 1 y 10

Tamaño	CFM	VS	26"PE		28"PE		30"PE		32"PE		33"PE		34"PE		35"PE		36"PE		37"PE		38"PE		39"PE		
			RPM	BHP	RPM	BHP	RPM	BHP	RPM	BHP	RPM	BHP	RPM	BHP	RPM	BHP	RPM	BHP	RPM	BHP	RPM	BHP	RPM	BHP	RPM
621 MAX RPM 3900	500	2500	3042	3.6	3157	3.91	3268	4.22	3376	4.54	3429	4.7	3481	4.87	3533	5.03	3584	5.2	3634	5.36	3684	5.53	3733	5.69	
	550	2750	3045	3.89	3158	4.21	3268	4.55	3375	4.89	3427	5.05	3479	5.23	3530	5.4	3580	5.57	3630	5.75	3679	5.92	3727	6.1	
	600	3000	3053	4.19	3164	4.53	3272	4.88	3377	5.23	3429	5.42	3480	5.6	3530	5.78	3580	5.96	3629	6.14	3678	6.33	3726	6.51	
	650	3250	3064	4.5	3174	4.86	3280	5.23	3384	5.6	3435	5.79	3485	5.98	3535	6.17	3584	6.36	3632	6.55	3680	6.74	3728	6.94	
	700	3500	3078	4.82	3186	5.2	3292	5.59	3394	5.98	3444	6.17	3494	6.37	3543	6.57	3591	6.77	3639	6.97	3686	7.17	3733	7.38	
	750	3750	3096	5.16	3202	5.55	3306	5.96	3407	6.37	3456	6.57	3505	6.78	3554	6.99	3602	7.2	3649	7.41	3696	7.62	3742	7.83	
	800	4000	3116	5.51	3221	5.92	3323	6.34	3423	6.77	3472	6.99	3520	7.2	3568	7.42	3615	7.64	3662	7.86	3708	8.08	3753	8.3	
	850	4250	3139	5.87	3243	6.31	3343	6.75	3442	7.2	3490	7.42	3537	7.64	3585	7.87	3631	8.09	3677	8.32	3723	8.55	3768	8.78	
	900	4500	3164	6.26	3266	6.71	3366	7.17	3463	7.63	3510	7.86	3557	8.1	3604	8.33	3650	8.57	3695	8.8	3740	9.04	3785	9.28	
	950	4750	3191	6.66	3292	7.13	3390	7.61	3486	8.09	3533	8.33	3579	8.57	3625	8.81	3671	9.06	3716	9.31	3760	9.55	3804	9.8	
	1000	5000	3220	7.08	3319	7.56	3416	8.06	3511	8.56	3557	8.81	3603	9.06	3649	9.32	3694	9.57	3738	9.82	3782	10.1	3825	10.3	
	1050	5250	3250	7.51	3349	8.02	3444	8.53	3538	9.05	3584	9.31	3629	9.57	3674	9.83	3718	10.1	3762	10.4	3806	10.6	3849	10.9	
1100	5500	3283	7.97	3380	8.5	3474	9.03	3567	9.57	3612	9.83	3657	10.1	3701	10.4	3745	10.7	3788	10.9	3831	11.2	3874	11.5		
1200	6000	3352	8.96	3446	9.52	3539	10.1	3629	10.7	3673	10.9	3717	11.2	3760	11.5	3803	11.8	3845	12.1	3887	12.4				

Tamaño	CFM	VS	32"PE		34"PE		35"PE		36"PE		37"PE		38"PE		39"PE		40"PE		41"PE		42"PE		43"PE		
			RPM	BHP	RPM	BHP	RPM	BHP	RPM	BHP	RPM	BHP	RPM	BHP	RPM	BHP	RPM	BHP	RPM	BHP	RPM	BHP	RPM	BHP	RPM
622 MAX RPM 3900	500	2500	3260	4.69	3363	5.03	3414	5.2	3464	5.38	3513	5.55	3561	5.72	3609	5.89	3657	6.07	3704	6.25	3750	6.42	3796	6.6	
	550	2750	3255	5.03	3357	5.39	3406	5.56	3456	5.75	3504	5.93	3552	6.11	3600	6.3	3647	6.49	3693	6.67	3739	6.86	3785	7.05	
	600	3000	3254	5.36	3354	5.74	3403	5.93	3452	6.12	3500	6.32	3547	6.51	3594	6.7	3641	6.9	3686	7.1	3732	7.3	3777	7.5	
	650	3250	3257	5.7	3356	6.1	3404	6.3	3452	6.5	3499	6.7	3546	6.91	3592	7.11	3638	7.32	3683	7.52	3728	7.73	3773	7.94	
	700	3500	3264	6.05	3361	6.47	3409	6.68	3456	6.89	3502	7.1	3549	7.32	3594	7.53	3639	7.74	3684	7.96	3728	8.17	3772	8.39	
	750	3750	3275	6.42	3370	6.85	3417	7.07	3463	7.28	3509	7.5	3555	7.73	3600	7.95	3644	8.17	3688	8.4	3732	8.63	3775	8.85	
	800	4000	3288	6.79	3382	7.24	3429	7.47	3474	7.69	3520	7.93	3564	8.15	3609	8.39	3653	8.62	3696	8.85	3739	9.09	3782	9.32	
	850	4250	3305	7.19	3398	7.66	3443	7.89	3488	8.12	3533	8.36	3577	8.6	3621	8.84	3664	9.08	3707	9.32	3749	9.56	3791	9.8	
	900	4500	3324	7.6	3416	8.09	3460	8.32	3505	8.57	3549	8.81	3592	9.05	3635	9.3	3678	9.55	3720	9.8	3762	10.1	3804	10.3	
	950	4750	3346	8.04	3436	8.53	3480	8.78	3524	9.03	3567	9.28	3610	9.53	3653	9.79	3695	10.1	3737	10.3	3778	10.6	3819	10.8	
	1000	5000	3370	8.5	3459	9.01	3502	9.26	3545	9.52	3588	9.78	3631	10	3673	10.3	3714	10.6	3755	10.8	3796	11.1	3837	11.4	
	1050	5250	3395	8.98	3483	9.5	3526	9.77	3569	10	3611	10.3	3653	10.6	3694	10.8	3735	11.1	3776	11.4	3816	11.7	3856	11.9	
1100	5500	3423	9.5	3510	10	3552	10.3	3594	10.6	3636	10.8	3677	11.1	3718	11.4	3759	11.7	3799	12	3839	12.2	3878	12.5		
1200	6000	3482	10.6	3567	11.2	3609	11.5	3650	11.7	3690	12	3731	12.3	3771	12.6	3810	12.9	3850	13.2	3889	13.5				

Tamaño	CFM	VS	45"PE		46"PE		47"PE		48"PE		49"PE		50"PE		52"PE		54"PE		55"PE		56"PE		57"PE		
			RPM	BHP	RPM	BHP	RPM	BHP	RPM	BHP	RPM	BHP	RPM	BHP	RPM	BHP	RPM	BHP	RPM	BHP	RPM	BHP	RPM	BHP	RPM
624 MAX RPM 3800	500	2500	3461	8.43	3501	8.67	3540	8.91	3579	9.15	3617	9.38	3655	9.62	3730	10.1									
	550	2750	3449	8.85	3489	9.1	3528	9.34	3567	9.59	3605	9.84	3643	10.1	3718	10.6	3791	11.1							
	600	3000	3438	9.26	3477	9.51	3516	9.77	3555	10	3593	10.3	3631	10.6	3706	11.1	3779	11.6							
	650	3250	3427	9.67	3467	9.94	3506	10.2	3544	10.5	3582	10.7	3620	11	3694	11.6	3768	12.1							
	700	3500	3418	10.1	3457	10.4	3496	10.6	3534	10.9	3572	11.2	3610	11.5	3684	12	3757	12.6	3793	12.9					
	750	3750	3410	10.5	3449	10.8	3488	11.1	3526	11.4	3564	11.6	3601	11.9	3675	12.5	3747	13.1	3783	13.4					
	800	4000	3404	10.9	3443	11.2	3481	11.5	3519	11.8	3556	12.1	3593	12.4	3667	13	3739	13.6	3775	13.9					
	850	4250	3400	11.4	3438	11.7	3476	12	3514	12.3	3551	12.6	3588	12.9	3660	13.5	3732	14.1	3767	14.4					
	900	4500	3398	11.8	3436	12.1	3473	12.4	3510	12.7	3547	13	3584	13.3	3656	14	3727	14.6	3762	14.9	3797	15.2			
	950	4750	3398	12.3	3435	12.6	3472	12.9	3509	13.2	3545	13.5	3581	13.8	3653	14.5	3723	15.1	3758	15.5	3793	15.8			
	1000	5000	3400	12.7	3437	13.1	3473	13.4	3510	13.7	3546	14	3581	14.3	3652	15	3722	15.7	3756	16	3790	16.3			
	1050	5250	3404	13.2	3440	13.6	3476	13.9	3512	14.2	3548	14.6	3583	14.9	3653	15.5	3722	16.2	3756	16.6	3790	16.9			
1100	5500	3410	13.8	3446	14.1	3481	14.4	3517	14.8	3552	15.1	3587	15.4	3656	16.1	3724	16.8	3758	17.2	3792	17.5				
1200	6000	3426	14.9	3461	15.2	3496	15.5	3531	15.9	3566	16.2	3600	16.6	3668	17.3	3734	18	3767	18.4						

Tamaño	CFM	VS	43 1/2"PE		44"PE		44 1/2"PE		45"PE		45 1/2"PE		46"PE		46 1/2"PE		47"PE		47 1/2"PE		48"PE		48 1/2"PE	
			RPM	BHP	RPM	BHP	RPM	BHP	RPM	BHP	RPM	BHP	RPM	BHP	RPM	BHP	RPM	BHP	RPM	BHP	RPM	BHP	RPM	BHP
625 MAX RPM 3800	500	2500	3319	8.31	3339	8.43	3358	8.55	3378	8.67	3398	8.8	3417	8.91	3437	9.04	3456	9.16	3475	9.28	3494	9.41	3513	9.53
	550	2750	3304	8.71	3324	8.83	3343	8.95	3363	9.08	3382	9.21	3402	9.34	3421	9.46	3440	9.59	3459	9.72	3478	9.85	3497	9.98
	600	3000	3290	9.09	3310	9.22	3330	9.35	3349	9.48	3369	9.62	3388	9.75	3407	9.88	3426	10	3445	10.1	3464	10.3	3483	10.4
	650	3250	3279	9.47	3299	9.61	3318	9.74	3337	9.88	3357	10	3376	10.2	3395	10.3	3414	10.4	3433	10.6	3452	10.7	3470	10.8
	700	3500	3269	9.86	3289	10	3308	10.1	3327	10.3	3347	10.4	3366	10.6	3385	10.7	3403	10.8	3422	11	3441	11.1	3459	11.3
	750	3750	3262	10.3	3281	10.4	3300	10.5	3319	10.7	3338	10.8	3357	11	3376	11.1	3395	11.3	3413	11.4	3432	11.6	3450	11.7
	800	4000	3256	10.7	3275	10.8	3294	11	3313	11.1	3332	11.3	3351	11.4	3369	11.6	3388	11.7	3406	11.8	3425	12	3443	12.2
	850	4250	32																					



EVISA Modelo TURH-TURA Arr. 1 y 10

Tamaño	CFM	VS	46"PE		46 1/2"PE		47"PE		47 1/2"PE		48"PE		48 1/2"PE		49"PE		49 1/2"PE		50"PE		51"PE		52"PE	
			RPM	BHP	RPM	BHP	RPM	BHP	RPM	BHP	RPM	BHP	RPM	BHP	RPM	BHP	RPM	BHP	RPM	BHP	RPM	BHP	RPM	BHP
626 MAX RPM 3800	500	2500	3309	8.87	3328	8.99	3346	9.11	3365	9.23	3383	9.35	3402	9.48	3420	9.6	3438	9.72	3456	9.84	3492	10.1	3528	10.4
	550	2750	3294	9.3	3313	9.42	3332	9.55	3350	9.68	3369	9.81	3387	9.93	3405	10.1	3423	10.2	3441	10.3	3477	10.6	3513	10.8
	600	3000	3281	9.73	3299	9.86	3318	9.99	3336	10.1	3355	10.3	3373	10.4	3391	10.5	3409	10.7	3427	10.8	3463	11.1	3498	11.3
	650	3250	3269	10.2	3287	10.3	3306	10.4	3324	10.6	3342	10.7	3360	10.9	3378	11	3396	11.1	3414	11.3	3450	11.5	3485	11.8
	700	3500	3258	10.6	3276	10.7	3295	10.9	3313	11	3331	11.2	3349	11.3	3367	11.5	3385	11.6	3403	11.7	3438	12	3473	12.3
	750	3750	3249	11.1	3267	11.2	3285	11.3	3303	11.5	3321	11.6	3339	11.8	3357	11.9	3375	12.1	3393	12.2	3428	12.5	3463	12.8
	800	4000	3242	11.5	3260	11.6	3278	11.8	3296	11.9	3314	12.1	3332	12.2	3349	12.4	3367	12.5	3384	12.7	3419	13	3454	13.3
	850	4250	3237	11.9	3255	12.1	3273	12.3	3290	12.4	3308	12.6	3326	12.7	3343	12.9	3361	13	3378	13.2	3413	13.5	3447	13.8
	900	4500	3234	12.4	3252	12.6	3269	12.7	3287	12.9	3304	13	3322	13.2	3339	13.4	3356	13.5	3374	13.7	3408	14	3442	14.3
	950	4750	3233	12.9	3251	13	3268	13.2	3285	13.4	3303	13.5	3320	13.7	3337	13.9	3354	14	3371	14.2	3405	14.5	3439	14.8
	1000	5000	3234	13.4	3252	13.5	3269	13.7	3286	13.9	3303	14	3320	14.2	3337	14.4	3354	14.5	3371	14.7	3404	15	3437	15.4
	1050	5250	3237	13.9	3254	14	3271	14.2	3288	14.4	3305	14.5	3322	14.7	3339	14.9	3356	15.1	3372	15.2	3405	15.6	3438	15.9
1100	5500	3242	14.4	3259	14.6	3276	14.7	3292	14.9	3309	15.1	3326	15.3	3342	15.4	3359	15.6	3375	15.8	3408	16.1	3441	16.5	
1200	6000	3254	15.5	3271	15.7	3287	15.9	3304	16	3321	16.2	3337	16.4	3353	16.6	3370	16.8	3386	16.9	3418	17.3	3450	17.7	

Tamaño	CFM	VS	8"PE		8 1/2"PE		9"PE		10"PE		10 1/2"PE		11"PE		12"PE		13"PE		14"PE		15"PE		16"PE	
			RPM	BHP	RPM	BHP	RPM	BHP	RPM	BHP	RPM	BHP	RPM	BHP	RPM	BHP	RPM	BHP	RPM	BHP	RPM	BHP	RPM	BHP
815 MAX RPM 4000	800	2286	2391	1.56	2455	1.65	2517	1.74	2637	1.93	2696	2.02	2753	2.12	2864	2.31	2972	2.5	3076	2.7	3177	2.9	3275	3.1
	900	2571	2436	1.79	2498	1.89	2558	1.99	2676	2.2	2733	2.3	2788	2.4	2897	2.61	3003	2.82	3105	3.03	3204	3.25	3300	3.46
	1000	2857	2487	2.05	2547	2.16	2606	2.27	2720	2.48	2776	2.6	2830	2.71	2937	2.93	3040	3.16	3140	3.39	3237	3.62	3332	3.86
	1100	3143	2545	2.33	2603	2.45	2660	2.57	2771	2.8	2825	2.92	2878	3.04	2982	3.28	3083	3.53	3181	3.77	3276	4.02	3369	4.27
	1200	3429	2609	2.65	2665	2.78	2720	2.9	2828	3.15	2880	3.28	2932	3.41	3033	3.67	3131	3.92	3227	4.19	3320	4.45	3411	4.72
	1300	3714	2677	3	2732	3.14	2785	3.27	2890	3.54	2941	3.67	2991	3.81	3089	4.08	3185	4.36	3278	4.64	3369	4.92	3458	5.2
	1400	4000	2750	3.39	2803	3.53	2855	3.67	2956	3.96	3005	4.1	3054	4.24	3150	4.53	3243	4.83	3334	5.12	3423	5.42	3510	5.72
	1500	4286	2826	3.82	2877	3.97	2928	4.12	3026	4.42	3075	4.57	3122	4.72	3215	5.03	3306	5.33	3395	5.65	3481	5.96	3566	6.27
	1600	4571	2905	4.3	2955	4.45	3004	4.61	3100	4.92	3147	5.08	3194	5.24	3284	5.56	3373	5.89	3459	6.21	3544	6.54	3627	6.88
	1800	5143	3069	5.38	3117	5.55	3165	5.72	3257	6.07	3301	6.24	3346	6.42	3432	6.77	3517	7.13	3599	7.49	3680	7.85	3759	8.21
	1900	5429	3154	5.99	3201	6.17	3248	6.36	3338	6.72	3382	6.9	3425	7.09	3510	7.46	3593	7.83	3673	8.2	3752	8.58	3830	8.96
	2000	5714	3239	6.66	3286	6.85	3332	7.04	3421	7.42	3464	7.61	3507	7.81	3590	8.19	3671	8.58	3750	8.97	3828	9.37	3904	9.76
2100	6000	3325	7.37	3372	7.58	3417	7.78	3505	8.18	3548	8.38	3590	8.58	3672	8.99	3752	9.39	3829	9.8	3905	10.2	3980	10.6	
2200	6286	3411	8.15	3458	8.36	3503	8.57	3590	8.99	3633	9.21	3674	9.41	3755	9.84	3834	10.3	3910	10.7	3985	11.1			

Tamaño	CFM	VS	10"PE		11"PE		12"PE		13"PE		14"PE		15"PE		16"PE		17"PE		18"PE		19"PE		20"PE	
			RPM	BHP	RPM	BHP	RPM	BHP	RPM	BHP	RPM	BHP	RPM	BHP	RPM	BHP	RPM	BHP	RPM	BHP	RPM	BHP	RPM	BHP
816 MAX RPM 4000	800	2286	2464	1.88	2573	2.07	2677	2.26	2779	2.45	2877	2.64	2972	2.84	3064	3.04	3154	3.24	3242	3.44	3327	3.65	3411	3.85
	900	2571	2499	2.14	2605	2.34	2707	2.55	2806	2.75	2902	2.96	2995	3.17	3086	3.39	3174	3.6	3260	3.82	3344	4.04	3427	4.27
	1000	2857	2541	2.43	2644	2.65	2743	2.86	2840	3.09	2933	3.31	3025	3.54	3113	3.76	3200	4	3285	4.23	3367	4.47	3448	4.7
	1100	3143	2588	2.75	2688	2.98	2785	3.21	2879	3.45	2971	3.69	3060	3.93	3147	4.17	3232	4.42	3315	4.67	3396	4.92	3475	5.17
	1200	3429	2640	3.09	2738	3.34	2832	3.59	2924	3.84	3014	4.1	3101	4.35	3186	4.61	3269	4.88	3350	5.14	3430	5.41	3508	5.68
	1300	3714	2696	3.47	2792	3.74	2884	4	2974	4.27	3061	4.54	3146	4.81	3230	5.09	3311	5.37	3391	5.65	3468	5.93	3545	6.21
	1400	4000	2756	3.88	2849	4.17	2940	4.45	3027	4.73	3113	5.02	3196	5.31	3278	5.6	3357	5.9	3435	6.19	3512	6.49	3587	6.79
	1500	4286	2817	4.32	2909	4.63	2998	4.93	3084	5.24	3168	5.54	3250	5.85	3330	6.16	3408	6.47	3484	6.78	3559	7.09	3633	7.41
	1600	4571	2880	4.8	2972	5.13	3059	5.45	3144	5.77	3226	6.1	3307	6.43	3385	6.75	3461	7.07	3536	7.4	3610	7.73	3682	8.06
	1800	5143	3008	5.82	3099	6.21	3185	6.58	3269	6.96	3349	7.32	3427	7.69	3503	8.06	3577	8.42	3650	8.79	3721	9.15	3791	9.52
	1900	5429	3070	6.37	3162	6.79	3249	7.2	3332	7.6	3412	7.99	3490	8.38	3565	8.77	3638	9.15	3710	9.54	3780	9.93	3849	10.3
	2000	5714	3130	6.93	3224	7.39	3313	7.84	3396	8.27	3476	8.69	3553	9.11	3628	9.52	3701	9.93	3772	10.3	3841	10.8	3909	11.2
2100	6000	3186	7.48	3284	8	3375	8.5	3459	8.96	3540	9.42	3617	9.87	3692	10.3	3764	10.7	3835	11.2	3903	11.6	3971	12	
2200	6286	3236	8.02	3340	8.62	3434	9.16	3521	9.68	3603	10.2	3681	10.7	3756	11.1	3828	11.6	3898	12.1	3967	12.5			

Tamaño	CFM	VS	10"PE		12"PE		14"PE		16"PE		17"PE		18"PE		19"PE		20"PE		21"PE		22"PE		23"PE	
			RPM	BHP	RPM	BHP	RPM	BHP	RPM	BHP	RPM	BHP	RPM	BHP	RPM	BHP	RPM	BHP	RPM	BHP	RPM	BHP	RPM	BHP
817 MAX RPM 4000	800	2286	2353	1.84	2557	2.2	2748	2.58	2928	2.96	3015	3.16	3099	3.36	3182	3.56	3262	3.76	3342	3.96	3419	4.17	3495	



EVISA Modelo TURH-TURA Arr. 1 y 10

Tamaño	CFM	VS	16"PE		18"PE		20"PE		21"PE		22"PE		23"PE		24"PE		25"PE		26"PE		27"PE		28"PE		
			RPM	BHP	RPM	BHP	RPM	BHP	RPM	BHP	RPM	BHP	RPM	BHP	RPM	BHP	RPM	BHP	RPM	BHP	RPM	BHP	RPM	BHP	RPM
818 MAX RPM 4000	800	2286	2757	3.11	2919	3.53	3075	3.97	3150	4.19	3223	4.41	3296	4.64	3367	4.86	3436	5.09	3505	5.32	3572	5.55	3638	5.79	
	900	2571	2773	3.45	2931	3.9	3083	4.37	3157	4.61	3229	4.84	3300	5.09	3369	5.33	3438	5.57	3505	5.82	3571	6.07	3636	6.32	
	1000	2857	2795	3.81	2950	4.29	3099	4.79	3171	5.04	3242	5.3	3311	5.55	3379	5.81	3446	6.07	3512	6.34	3577	6.6	3641	6.87	
	1100	3143	2823	4.2	2975	4.71	3121	5.24	3191	5.5	3260	5.77	3328	6.04	3395	6.32	3461	6.6	3526	6.87	3590	7.16	3653	7.44	
	1200	3429	2855	4.61	3005	5.16	3147	5.71	3217	6	3285	6.28	3351	6.57	3417	6.86	3482	7.15	3545	7.44	3608	7.74	3670	8.04	
	1300	3714	2892	5.07	3038	5.64	3179	6.23	3247	6.53	3313	6.82	3379	7.12	3444	7.43	3507	7.73	3570	8.04	3631	8.35	3692	8.67	
	1400	4000	2931	5.57	3075	6.17	3213	6.78	3280	7.09	3346	7.4	3411	7.72	3474	8.03	3537	8.36	3598	8.68	3659	9.01	3718	9.33	
	1500	4286	2972	6.09	3115	6.73	3251	7.37	3317	7.69	3382	8.02	3445	8.35	3508	8.68	3569	9.02	3630	9.35	3690	9.7	3749	10	
	1600	4571	3016	6.67	3157	7.33	3291	8	3356	8.34	3420	8.68	3483	9.03	3545	9.38	3605	9.72	3665	10.1	3724	10.4	3782	10.8	
	1800	5143	3111	7.95	3247	8.67	3378	9.41	3441	9.77	3503	10.1	3565	10.5	3625	10.9	3684	11.3	3742	11.7	3800	12	3856	12.4	
	1900	5429	3163	8.66	3296	9.42	3424	10.2	3487	10.6	3548	11	3608	11.3	3668	11.7	3726	12.1	3784	12.5	3841	12.9	3897	13.3	
	2000	5714	3217	9.42	3347	10.2	3473	11	3534	11.4	3595	11.8	3654	12.2	3713	12.6	3771	13	3828	13.4	3884	13.9	3939	14.3	
2100	6000	3274	10.2	3400	11.1	3523	11.9	3584	12.3	3643	12.7	3702	13.1	3760	13.6	3817	14	3873	14.4	3928	14.8	3983	15.3		
2200	6286	3334	11.1	3456	12	3576	12.8	3636	13.3	3694	13.7	3752	14.1	3809	14.6	3865	15	3920	15.4	3975	15.9				

Tamaño	CFM	VS	20"PE		22"PE		24"PE		26"PE		28"PE		29"PE		30"PE		31"PE		32"PE		33"PE		34"PE		
			RPM	BHP	RPM	BHP	RPM	BHP	RPM	BHP	RPM	BHP	RPM	BHP	RPM	BHP	RPM	BHP	RPM	BHP	RPM	BHP	RPM	BHP	RPM
819 MAX RPM 3900	800	2286	2848	4	2988	4.46	3124	4.95	3254	5.44	3380	5.95	3442	6.2	3502	6.46	3562	6.72	3621	6.99	3679	7.26	3736	7.53	
	900	2571	2848	4.35	2986	4.84	3119	5.35	3247	5.87	3372	6.4	3432	6.67	3492	6.94	3551	7.22	3609	7.49	3666	7.77	3723	8.06	
	1000	2857	2853	4.73	2989	5.25	3120	5.78	3246	6.32	3369	6.88	3429	7.16	3487	7.44	3545	7.73	3603	8.02	3659	8.31	3715	8.61	
	1100	3143	2864	5.14	2997	5.68	3126	6.24	3250	6.8	3371	7.39	3430	7.68	3488	7.98	3545	8.28	3602	8.58	3657	8.88	3712	9.19	
	1200	3429	2878	5.58	3010	6.15	3137	6.73	3259	7.32	3378	7.93	3436	8.24	3493	8.54	3549	8.85	3605	9.17	3660	9.49	3714	9.8	
	1300	3714	2897	6.05	3026	6.65	3151	7.26	3271	7.87	3388	8.5	3446	8.83	3502	9.15	3558	9.47	3612	9.79	3667	10.1	3720	10.5	
	1400	4000	2918	6.55	3046	7.18	3168	7.81	3287	8.46	3403	9.12	3459	9.45	3515	9.79	3570	10.1	3624	10.5	3677	10.8	3730	11.2	
	1500	4286	2942	7.08	3068	7.74	3189	8.41	3306	9.08	3420	9.77	3476	10.1	3531	10.5	3585	10.8	3638	11.2	3691	11.5	3743	11.9	
	1600	4571	2969	7.64	3093	8.34	3212	9.03	3328	9.74	3440	10.5	3495	10.8	3549	11.2	3603	11.5	3656	11.9	3708	12.3	3759	12.7	
	1800	5143	3028	8.85	3149	9.61	3265	10.4	3378	11.2	3488	11.9	3541	12.3	3594	12.7	3646	13.1	3698	13.5	3749	13.9	3799	14.3	
	1900	5429	3061	9.5	3180	10.3	3295	11.1	3406	11.9	3515	12.7	3568	13.1	3620	13.5	3671	13.9	3722	14.4	3773	14.8	3822	15.2	
	2000	5714	3095	10.2	3213	11	3326	11.9	3436	12.7	3543	13.5	3596	14	3647	14.4	3698	14.8	3749	15.3	3799	15.7	3848	16.1	
2100	6000	3131	10.9	3247	11.8	3359	12.6	3468	13.5	3574	14.4	3626	14.9	3677	15.3	3727	15.7	3777	16.2	3826	16.6	3875	17.1		
2200	6286	3169	11.7	3283	12.6	3394	13.5	3501	14.4	3606	15.3	3657	15.8	3707	16.2	3757	16.7	3807	17.2	3855	17.6				

Tamaño	CFM	VS	22"PE		24"PE		26"PE		28"PE		30"PE		32"PE		34"PE		35"PE		36"PE		37"PE		38"PE		
			RPM	BHP	RPM	BHP	RPM	BHP	RPM	BHP	RPM	BHP	RPM	BHP	RPM	BHP	RPM	BHP	RPM	BHP	RPM	BHP	RPM	BHP	RPM
820 MAX RPM 3900	800	2286	2867	4.48	2998	4.97	3124	5.46	3246	5.96	3364	6.47	3479	6.99	3590	7.51	3645	7.78	3699	8.05	3752	8.31	3805	8.59	
	900	2571	2861	4.86	2990	5.37	3114	5.89	3234	6.42	3351	6.97	3464	7.52	3574	8.08	3628	8.36	3682	8.65	3734	8.93	3786	9.22	
	1000	2857	2861	5.26	2987	5.8	3110	6.35	3228	6.91	3343	7.48	3455	8.06	3563	8.64	3617	8.95	3669	9.24	3721	9.54	3773	9.85	
	1100	3143	2866	5.68	2990	6.24	3111	6.82	3227	7.41	3340	8	3450	8.61	3557	9.23	3610	9.54	3662	9.86	3713	10.2	3764	10.5	
	1200	3429	2876	6.14	2998	6.72	3116	7.32	3231	7.94	3342	8.56	3450	9.19	3556	9.84	3608	10.2	3659	10.5	3710	10.8	3760	11.2	
	1300	3714	2890	6.62	3010	7.24	3126	7.86	3239	8.5	3348	9.14	3455	9.8	3559	10.5	3610	10.8	3661	11.2	3710	11.5	3760	11.8	
	1400	4000	2907	7.14	3025	7.78	3139	8.43	3250	9.09	3358	9.76	3463	10.5	3566	11.1	3616	11.5	3666	11.9	3715	12.2	3764	12.6	
	1500	4286	2927	7.69	3043	8.36	3156	9.04	3265	9.72	3372	10.4	3475	11.1	3576	11.9	3626	12.2	3675	12.6	3724	13	3772	13.3	
	1600	4571	2950	8.29	3065	8.98	3176	9.68	3283	10.4	3388	11.1	3490	11.9	3590	12.6	3639	13	3687	13.4	3735	13.7	3783	14.1	
	1800	5143	3002	9.58	3114	10.3	3222	11.1	3327	11.9	3429	12.6	3528	13.4	3625	14.2	3673	14.6	3720	15	3767	15.4	3813	15.8	
	1900	5429	3031	10.3	3142	11.1	3248	11.9	3352	12.7	3453	13.5	3551	14.3	3647	15.1	3694	15.5	3740	15.9	3787	16.4	3832	16.8	
	2000	5714	3062	11	3171	11.8	3276	12.7	3379	13.5	3478	14.3	3575	15.2	3670	16	3717	16.5	3763	16.9	3808	17.3	3853	17.8	
2100	6000	3094	11.8	3202	12.7	3306	13.5	3407	14.4	3506	15.2	3602	16.1	3695	17	3741	17.4	3787	17.9	3832	18.3	3876	18.8		
2200	6286	3143	12.8	3234	13.5	3337	14.4	3437	15.3	3534	16.2	3629	17.1	3722	18	3768	18.5	3813	18.9	3857	19.4				

Tamaño	CFM	VS	28"PE		30"PE		32"PE		34"PE		36"PE		38"PE		40"PE		41"PE		42"PE		43"PE		44"PE	
			RPM	BHP	RPM	BHP	RPM	BHP	RPM	BHP	RPM	BHP	RPM	BHP	RPM	BHP	RPM	BHP	RPM	BHP	RPM	BHP	RPM	BHP
821 MAX RPM 3900	800	2286	3114	5.81	3230	6.29	3343	6.77	3452	7.26	3559	7.76	3663	8.26	3764	8.77	3814	9.03	3864	9.29				
	900	2571	3093	6.32	3207	6.83	3319	7.36	3427	7.88	3532	8.42	3635	8.96	3736	9.51	3785	9.78	3834	10.1				
	1000	2857	3079	6.83	3191	7.38	3300	7.94	3407	8.5	3511	9.07	3612	9.65	3712	10.2	3761	10.5	3809	10.8				
	1100	3143	3071	7.35	3181	7.93	3288	8.53	3393	9.13	3495	9.73	3595	10.3	3693	11	3741	11.3	3789	11.6				
	1200	3429	3069	7.88	3176	8.49	3282	9.12	3384	9.75	3485	10.4	3583	11	3679	11.7	3727	12	3774	12.4				
	1300	3714	3072	8.42	3178	9.08	3281	9.73	3381	10.4	3480	11.1	3576	11.8	3671	12.4	3718	12.8	3764	13.1				
	1400	4000	3080	8.99	3184	9.67	3285	10.4	3383	11.1	3480	11.8	3575											



EVISA Modelo TURH-TURA Arr. 1 y 10

Tamaño	CFM	VS	32"PE		34"PE		36"PE		38"PE		40"PE		42"PE		43"PE		44"PE		945"PE		46"PE		47"PE	
			RPM	BHP	RPM	BHP	RPM	BHP	RPM	BHP	RPM	BHP	RPM	BHP	RPM	BHP	RPM	BHP	RPM	BHP	RPM	BHP	RPM	BHP
822 MAX RPM 3900	800	2286	3207	6.82	3313	7.31	3416	7.81	3517	8.31	3615	8.82	3711	9.33	3758	9.59	3805	9.85	3851	10.1	3896	10.4		
	900	2571	3182	7.42	3286	7.95	3388	8.48	3487	9.02	3584	9.57	3679	10.1	3726	10.4	3772	10.7	3818	11	3863	11.2		
	1000	2857	3163	8.02	3266	8.59	3366	9.16	3463	9.74	3559	10.3	3653	10.9	3699	11.2	3744	11.5	3790	11.8	3834	12.1	3879	12.4
	1100	3143	3151	8.62	3251	9.22	3349	9.83	3445	10.5	3539	11.1	3632	11.7	3677	12	3722	12.3	3767	12.7	3811	13	3854	13.3
	1200	3429	3145	9.23	3243	9.87	3339	10.5	3434	11.2	3526	11.8	3616	12.5	3661	12.8	3705	13.2	3749	13.5	3792	13.8	3835	14.2
	1300	3714	3146	9.86	3242	10.5	3336	11.2	3428	11.9	3518	12.6	3607	13.3	3651	13.6	3694	14	3737	14.3	3780	14.7	3822	15.1
	1400	4000	3152	10.5	3245	11.2	3337	11.9	3427	12.6	3516	13.4	3603	14.1	3646	14.5	3688	14.8	3731	15.2	3772	15.6	3814	16
	1500	4286	3162	11.2	3254	11.9	3344	12.6	3432	13.4	3519	14.2	3604	14.9	3646	15.3	3688	15.7	3729	16.1	3770	16.5	3811	16.9
	1600	4571	3177	11.9	3267	12.6	3355	13.4	3442	14.2	3527	15	3610	15.8	3652	16.2	3692	16.6	3733	17	3773	17.4	3813	17.8
	1800	5143	3217	13.4	3304	14.2	3389	15	3472	15.8	3554	16.7	3635	17.5	3674	18	3714	18.4	3753	18.8	3792	19.3	3830	19.7
	1900	5429	3241	14.2	3326	15	3410	15.9	3492	16.7	3573	17.6	3652	18.5	3691	18.9	3730	19.4	3768	19.8	3806	20.3	3844	20.7
	2000	5714	3267	15	3351	15.9	3434	16.8	3515	17.6	3594	18.5	3672	19.5	3711	19.9	3749	20.4	3787	20.8	3824	21.3	3861	21.8
2100	6000	3294	15.9	3378	16.8	3459	17.7	3539	18.6	3618	19.5	3694	20.5	3732	20.9	3770	21.4	3807	21.9	3844	22.4	3881	22.9	
2200	6286	3323	16.8	3406	17.7	3486	18.7	3565	19.6	3643	20.6	3719	21.5	3756	22	3794	22.5	3830	23	3867	23.5			

Tamaño	CFM	VS	35"PE		37"PE		39"PE		41"PE		43"PE		45"PE		46"PE		47"PE		48"PE		49"PE		50"PE	
			RPM	BHP	RPM	BHP	RPM	BHP	RPM	BHP	RPM	BHP	RPM	BHP	RPM	BHP	RPM	BHP	RPM	BHP	RPM	BHP	RPM	BHP
823 MAX RPM 3800	800	2286	3099	7.83	3188	8.36	3274	8.9	3359	9.45	3441	10	3523	10.6	3562	10.9	3602	11.1	3641	11.4	3680	11.7	3718	12
	900	2571	3096	8.47	3184	9.04	3269	9.6	3352	10.2	3434	10.8	3514	11.4	3554	11.7	3593	12	3631	12.3	3670	12.6	3708	12.9
	1000	2857	3099	9.16	3185	9.75	3269	10.3	3352	11	3432	11.6	3511	12.2	3550	12.5	3588	12.8	3627	13.1	3664	13.4	3702	13.8
	1100	3143	3107	9.9	3192	10.5	3275	11.1	3356	11.8	3435	12.4	3513	13.1	3551	13.4	3589	13.7	3627	14	3664	14.4	3701	14.7
	1200	3429	3120	10.7	3203	11.3	3284	12	3364	12.6	3442	13.3	3519	14	3557	14.3	3594	14.7	3631	15	3668	15.4	3705	15.7
	1300	3714	3136	11.5	3218	12.2	3298	12.9	3377	13.6	3454	14.3	3529	15	3566	15.3	3603	15.7	3640	16	3676	16.4	3712	16.7
	1400	4000	3157	12.4	3237	13.1	3316	13.8	3393	14.6	3469	15.3	3543	16	3580	16.4	3616	16.7	3652	17.1	3688	17.5	3724	17.9
	1500	4286	3181	13.4	3260	14.1	3337	14.8	3413	15.6	3488	16.3	3561	17.1	3597	17.5	3633	17.9	3669	18.3	3704	18.6	3739	19
	1600	4571	3209	14.4	3286	15.1	3362	15.9	3437	16.7	3510	17.5	3582	18.3	3618	18.7	3653	19.1	3688	19.5	3723	19.9	3757	20.3
	1800	5143	3274	16.6	3349	17.4	3422	18.2	3494	19.1	3565	19.9	3634	20.8	3669	21.2	3703	21.6	3737	22.1	3771	22.5		
	1900	5429	3310	17.7	3384	18.6	3456	19.5	3527	20.4	3596	21.2	3665	22.1	3699	22.6	3732	23	3766	23.5	3799	23.9		
	2000	5714	3349	19	3421	19.9	3492	20.8	3562	21.7	3630	22.6	3698	23.5	3731	24	3764	24.5	3797	24.9				
2100	6000	3389	20.3	3461	21.2	3531	22.2	3599	23.1	3667	24.1	3733	25	3766	25.5	3799	26							
2200	6286	3431	21.7	3502	22.6	3571	23.6	3639	24.6	3705	25.6	3771	26.6											

Tamaño	CFM	VS	38"PE		40"PE		42"PE		44"PE		46"PE		47"PE		48"PE		49"PE		50"PE		51"PE		52"PE	
			RPM	BHP	RPM	BHP	RPM	BHP	RPM	BHP	RPM	BHP	RPM	BHP	RPM	BHP	RPM	BHP	RPM	BHP	RPM	BHP	RPM	BHP
824 MAX RPM 3800	800	2286	3104	7.33	3186	7.76	3267	8.2	3345	8.64	3423	9.09	3461	9.31	3499	9.53	3536	9.76	3573	9.98	3610	10.2	3646	10.4
	900	2571	3098	8.05	3180	8.52	3259	8.98	3337	9.46	3413	9.93	3451	10.2	3488	10.4	3525	10.7	3562	10.9	3598	11.2	3634	11.4
	1000	2857	3098	8.8	3178	9.29	3256	9.79	3333	10.3	3408	10.8	3446	11.1	3482	11.3	3519	11.6	3555	11.8	3591	12.1	3626	12.4
	1100	3143	3101	9.57	3180	10.1	3258	10.6	3334	11.2	3408	11.7	3445	12	3481	12.3	3517	12.5	3553	12.8	3588	13.1	3623	13.4
	1200	3429	3109	10.4	3187	11	3263	11.5	3338	12.1	3411	12.6	3448	12.9	3484	13.2	3519	13.5	3554	13.8	3589	14.1	3624	14.4
	1300	3714	3120	11.2	3197	11.8	3272	12.4	3346	13	3419	13.6	3454	13.9	3490	14.2	3525	14.5	3560	14.9	3594	15.2	3628	15.5
	1400	4000	3136	12.1	3211	12.8	3285	13.4	3358	14	3429	14.7	3464	15	3499	15.3	3534	15.6	3568	15.9	3602	16.3	3636	16.6
	1500	4286	3154	13.1	3229	13.7	3301	14.4	3373	15.1	3443	15.7	3478	16.1	3512	16.4	3547	16.7	3580	17.1	3614	17.4	3647	17.7
	1600	4571	3177	14.1	3250	14.8	3321	15.5	3391	16.1	3461	16.8	3495	17.2	3529	17.5	3562	17.9	3596	18.3	3629	18.6	3662	19
	1800	5143	3231	16.2	3301	17	3370	17.7	3438	18.5	3505	19.2	3538	19.6	3571	20	3603	20.4	3636	20.8	3668	21.2	3700	21.6
	1900	5429	3262	17.4	3331	18.2	3399	19	3466	19.7	3531	20.5	3564	20.9	3596	21.3	3628	21.7	3660	22.1	3691	22.5	3723	22.9
	2000	5714	3296	18.6	3364	19.4	3430	20.2	3496	21.1	3561	21.9	3592	22.3	3624	22.7	3656	23.1	3687	23.5	3718	24	3749	24.4
2100	6000	3333	19.9	3399	20.7	3465	21.6	3529	22.4	3592	23.3	3624	23.7	3655	24.2	3686	24.6	3717	25	3747	25.4	3778	25.9	
2200	6286	3372	21.3	3437	22.1	3501	23	3564	23.9	3627	24.8	3658	25.2	3688	25.7	3719	26.1	3749	26.6	3779	27			

Tamaño	CFM	VS	43"PE		44"PE		45"PE		45 1/2"PE		46"PE		47"PE		48"PE		49"PE		50"PE		50 1/2"PE		51"PE	
			RPM	BHP	RPM	BHP	RPM	BHP	RPM	BHP	RPM	BHP	RPM	BHP	RPM	BHP	RPM	BHP	RPM	BHP	RPM	BHP	RPM	BHP
825 MAX RPM 3800	800	2286	3226	10.2	3265	10.5	3303	10.8	3322	10.9	3341	11	3379	11.3	3416	11.6	3453	11.9	3490	12.2	3508	12.4	3526	12.5
	900	2571	3213	11	3252	11.3	3289	11.6	3308	11.7	3327	11.9	3364	12.2	3401	12.5	3437	12.8	3473	13.1	3491	13.3	3509	13.4
	1000	2857	3207	11.8	3244	12.1	3282	12.4	3300	12.5	3318	12.7	3355	13	3391	13.4	3427	13.7	3463	14	3480	14.2	3498	14.3
	1100	3143	3206	12.6	3243	12.9	3279	13.2	3297	13.4	3315	13.6	3351	13.9	3387	14.3	3422	14.6	3457	14.9	3475	15.1	3492	15.3
	1200	3429	3209	13.5	3246	13.8	3282	14.2	3300	14.3	3317	14.5	3353	14.9	3388	15.2	3423	15.6	3457	15.9	3474	16.1	3491	16.3
	1300	3714	3218	14.4	3254	14.8	3289	15.1	3306	15.3	3324	15.5	3359	15.8	3393	16.2	3427	16.6	3461	16.9	3478	17.1	3495	17.3
	1400	4000	3230	15.4	3265	15.8	3300	16.1	3317	16.3	3334	16.5	3369	1										



EVISA Modelo TURH-TURA Arr. 1 y 10

Tamaño	CFM	VS	26"PE		28"PE		30"PE		32"PE		34"PE		35"PE		36"PE		37"PE		38"PE		39"PE		40"PE	
			RPM	BHP	RPM	BHP	RPM	BHP	RPM	BHP	RPM	BHP	RPM	BHP	RPM	BHP	RPM	BHP	RPM	BHP	RPM	BHP	RPM	BHP
1022 MAX RPM 4000	1000	1818	2843	6.34	2955	6.9	3063	7.46	3168	8.03	3271	8.62	3321	8.91	3371	9.2	3420	9.49	3469	9.79	3517	10.1	3564	10.4
	1200	2182	2836	7.3	2943	7.92	3046	8.55	3148	9.19	3247	9.83	3295	10.2	3343	10.5	3391	10.8	3438	11.2	3485	11.5	3531	11.8
	1400	2545	2850	8.33	2952	9.01	3051	9.69	3149	10.4	3244	11.1	3291	11.5	3337	11.8	3383	12.2	3428	12.5	3473	12.9	3518	13.3
	1500	2727	2863	8.88	2963	9.58	3061	10.3	3156	11	3249	11.8	3295	12.1	3341	12.5	3385	12.9	3430	13.3	3474	13.6	3518	14
	1600	2909	2879	9.46	2978	10.2	3073	10.9	3167	11.7	3259	12.5	3304	12.8	3348	13.2	3392	13.6	3436	14	3479	14.4	3522	14.8
	1800	3273	2921	10.7	3016	11.5	3108	12.3	3199	13.1	3287	13.9	3331	14.3	3374	14.7	3417	15.2	3459	15.6	3501	16	3542	16.4
	2000	3636	2970	12.1	3063	13	3153	13.8	3241	14.7	3327	15.5	3369	16	3411	16.4	3452	16.9	3493	17.3	3534	17.7	3574	18.2
	2200	4000	3024	13.7	3115	14.6	3204	15.5	3290	16.4	3374	17.3	3415	17.8	3456	18.2	3496	18.7	3536	19.2	3576	19.7	3615	20.1
	2400	4364	3083	15.5	3172	16.4	3259	17.3	3344	18.3	3426	19.3	3467	19.8	3507	20.3	3546	20.7	3585	21.3	3624	21.7	3663	22.2
	2600	4727	3145	17.4	3233	18.4	3318	19.4	3401	20.4	3483	21.4	3523	22	3562	22.5	3601	23	3640	23.5	3678	24	3715	24.6
	2800	5091	3210	19.5	3296	20.6	3380	21.6	3462	22.7	3542	23.8	3582	24.3	3620	24.9	3659	25.4	3697	26	3734	26.5	3772	27.1
	3000	5455	3280	21.9	3364	23	3446	24.1	3526	25.2	3605	26.4	3644	27	3682	27.5	3720	28.1	3757	28.7	3794	29.2	3831	29.8
	3200	5818	3355	24.5	3435	25.6	3515	26.8	3593	28	3670	29.2	3708	29.8	3746	30.4	3783	31	3820	31.6	3857	32.2	3893	32.8
3300	6000	3394	25.9	3473	27.1	3551	28.3	3629	29.5	3705	30.7	3742	31.3	3779	31.9	3816	32.5	3853	33.2	3889	33.8			

Tamaño	CFM	VS	32"PE		34"PE		36"PE		38"PE		40"PE		42"PE		44"PE		46"PE		48"PE		49"PE		50"PE	
			RPM	BHP	RPM	BHP	RPM	BHP	RPM	BHP	RPM	BHP	RPM	BHP	RPM	BHP	RPM	BHP	RPM	BHP	RPM	BHP	RPM	BHP
1023 MAX RPM 3800	1000	1818	2984	8.85	3079	9.54	3172	10.2	3262	11	3350	11.7	3436	12.4	3520	13.2	3603	13.9	3684	14.7	3724	15.1	3763	15.5
	1200	2182	2969	9.79	3063	10.5	3154	11.3	3242	12.1	3329	12.8	3413	13.6	3496	14.4	3578	15.3	3657	16.1	3696	16.5	3735	16.9
	1400	2545	2964	10.8	3055	11.6	3145	12.4	3232	13.2	3317	14	3401	14.9	3482	15.7	3562	16.6	3640	17.5	3679	17.9	3717	18.4
	1500	2727	2963	11.3	3054	12.2	3143	13	3230	13.8	3314	14.7	3397	15.5	3478	16.4	3557	17.3	3635	18.2	3674	18.7	3712	19.1
	1600	2909	2965	11.9	3055	12.7	3143	13.6	3229	14.4	3313	15.3	3395	16.2	3476	17.1	3554	18	3632	19	3670	19.4	3707	19.9
	1800	3273	2971	13.1	3060	14	3147	14.9	3232	15.8	3315	16.7	3396	17.6	3475	18.6	3553	19.6	3629	20.5	3667	21	3704	21.5
	2000	3636	2982	14.4	3070	15.3	3156	16.3	3239	17.2	3321	18.2	3401	19.2	3479	20.2	3556	21.2	3632	22.2	3669	22.7	3706	23.2
	2200	4000	2997	15.7	3084	16.7	3168	17.7	3251	18.8	3332	19.8	3411	20.8	3488	21.9	3564	22.9	3638	24	3675	24.5	3712	25.1
	2400	4364	3016	17.2	3102	18.3	3185	19.3	3266	20.4	3346	21.5	3424	22.6	3500	23.7	3575	24.8	3649	25.9	3685	26.5	3721	27
	2600	4727	3039	18.8	3123	19.9	3205	21	3285	22.1	3364	23.3	3441	24.4	3516	25.6	3590	26.7	3663	27.9	3699	28.5	3734	29.1
	2800	5091	3066	20.4	3148	21.6	3229	22.8	3308	24	3385	25.2	3461	26.4	3535	27.6	3609	28.8	3680	30.1	3716	30.7	3751	31.3
	3000	5455	3096	22.2	3177	23.4	3256	24.7	3334	25.9	3410	27.2	3485	28.5	3558	29.7	3630	31	3701	32.3	3736	33	3770	33.6
	3200	5818	3130	24	3210	25.3	3287	26.6	3363	28	3438	29.3	3511	30.6	3584	32	3655	33.3	3724	34.7	3759	35.4	3793	36
3300	6000	3149	25	3227	26.3	3304	27.7	3379	29	3453	30.4	3526	31.8	3598	33.1	3668	34.5	3737	35.9	3771	36.6			

Tamaño	CFM	VS	38"PE		40"PE		42"PE		44"PE		46"PE		48"PE		50"PE		52"PE		54"PE		55"PE		56"PE	
			RPM	BHP	RPM	BHP	RPM	BHP	RPM	BHP	RPM	BHP	RPM	BHP	RPM	BHP	RPM	BHP	RPM	BHP	RPM	BHP	RPM	BHP
1024 MAX RPM 4000	1000	1818	3137	10.9	3222	11.6	3305	12.3	3386	13.1	3466	13.8	3544	14.6	3620	15.3	3696	16.1	3769	16.9				
	1200	2182	3115	12.1	3199	12.9	3281	13.7	3361	14.4	3439	15.2	3516	16	3592	16.9	3666	17.7	3738	18.5	3774	19		
	1400	2545	3101	13.3	3184	14.2	3264	15	3343	15.8	3421	16.7	3497	17.6	3571	18.5	3644	19.3	3716	20.2	3751	20.7	3787	21.1
	1500	2727	3097	14	3179	14.8	3259	15.7	3337	16.6	3414	17.5	3489	18.4	3563	19.3	3636	20.2	3707	21.1	3743	21.6	3778	22
	1600	2909	3094	14.6	3175	15.5	3255	16.4	3333	17.3	3409	18.2	3484	19.1	3557	20.1	3630	21	3701	22	3736	22.5	3770	22.9
	1800	3273	3092	16	3173	16.9	3251	17.9	3328	18.8	3403	19.8	3477	20.8	3550	21.8	3621	22.8	3691	23.8	3726	24.3	3760	24.8
	2000	3636	3096	17.4	3175	18.4	3252	19.4	3328	20.4	3402	21.4	3475	22.5	3547	23.5	3617	24.6	3687	25.6	3721	26.2	3755	26.7
	2200	4000	3104	18.8	3182	19.9	3258	21	3333	22	3406	23.1	3478	24.2	3549	25.3	3618	26.4	3687	27.6	3720	28.1	3754	28.7
	2400	4364	3116	20.4	3193	21.5	3268	22.6	3342	23.8	3414	24.9	3485	26.1	3555	27.2	3623	28.4	3691	29.6	3724	30.2	3757	30.8
	2600	4727	3132	22	3208	23.2	3282	24.4	3354	25.6	3425	26.8	3495	28	3564	29.2	3632	30.4	3699	31.7	3732	32.3	3764	32.9
	2800	5091	3152	23.7	3226	25	3299	26.2	3370	27.4	3441	28.7	3510	30	3578	31.3	3644	32.5	3710	33.9	3743	34.5	3775	35.2
	3000	5455	3176	25.6	3249	26.8	3320	28.1	3390	29.4	3459	30.8	3527	32.1	3594	33.4	3660	34.8	3725	36.1	3757	36.8	3789	37.5
	3200	5818	3203	27.5	3274	28.8	3345	30.2	3414	31.5	3482	32.9	3548	34.3	3614	35.7	3679	37.1	3743	38.5	3775	39.2		
3300	6000	3218	28.5	3288	29.8	3358	31.2	3427	32.6	3494	34	3560	35.4	3626	36.9	3690	38.3	3753	39.7	3785	40.5			

Tamaño	CFM	VS	44"PE		45"PE		46"PE		47"PE		48"PE		49"PE		50"PE		51"PE		52"PE		52 1/2"PE		53"PE	
			RPM	BHP	RPM	BHP	RPM	BHP	RPM	BHP	RPM	BHP	RPM	BHP	RPM	BHP	RPM	BHP	RPM	BHP	RPM	BHP	RPM	BHP
1025 MAX RPM 3800	1000	1818	3298	12.6	3337	12.9	3376	13.3	3415	13.6	3453	14	3491	14.3	3529	14.7	3566	15.1	3603	15.4	3621	15.6	3639	15.8
	1200	2182	3261	14.1	3300	14.4	3339	14.8	3377	15.2	3415	15.6	3453	16	3490	16.4	3527	16.8	3563	17.2	3582	17.4	3600	17.6
	1400	2545	3232	15.6	3270	16	3308	16.4	3346	16.8	3384	17.2	3421	17.7	3458	18.1	3494	18.5	3530	18.9	3548	19.1	3566	19.3
	1500	2727	3220	16.3	3258	16.7	3296	17.2	3333	17.6	3371	18.1	3407	18.5	3444	18.9	3480	19.4	3516	19.8	3534	20	3552	20.3
	1600	2909	3209	17.1	3247	17.5	3285	18	3322	18.4	3359	18.9	3396	19.3	3432	19.8	3468	20.2	3504	20.7	3521	20.9	3539	21.2
	1800	3273	3195	18.6	3232	19.1	3269	19.6	3306	20	3342	20.5	3378	21	3414	21.5	3449	22	3484	22.5	3501	22.7	3519	23
	2000	3636	3188	20.2	3224	20.7	3261	21.2	3296	21.7	333													



EVISA Modelo TURH-TURA Arr. 1 y 10

Tamaño	CFM	VS	46"PE		47"PE		48"PE		49"PE		50"PE		51"PE		52"PE		53"PE		54"PE		55"PE		56"PE	
			RPM	BHP	RPM	BHP	RPM	BHP	RPM	BHP	RPM	BHP	RPM	BHP	RPM	BHP	RPM	BHP	RPM	BHP	RPM	BHP	RPM	BHP
1026	1000	1818	3261	13.4	3298	13.8	3335	14.1	3372	14.5	3409	14.9	3445	15.3	3480	15.6	3516	16	3551	16.4	3586	16.7	3620	17.1
	1200	2182	3223	14.9	3260	15.3	3297	15.7	3333	16.1	3369	16.5	3405	16.9	3440	17.3	3475	17.7	3510	18.1	3544	18.5	3579	18.9
	1400	2545	3193	16.4	3229	16.8	3265	17.2	3301	17.6	3337	18.1	3372	18.5	3407	18.9	3441	19.3	3476	19.8	3510	20.2	3544	20.7
	1500	2727	3180	17.1	3216	17.5	3252	18	3288	18.4	3323	18.9	3358	19.3	3393	19.8	3427	20.2	3461	20.7	3495	21.1	3529	21.6
	1600	2909	3170	17.9	3206	18.3	3241	18.8	3277	19.2	3312	19.7	3346	20.1	3381	20.6	3415	21.1	3449	21.5	3482	22	3515	22.5
	1800	3273	3155	19.4	3190	19.9	3225	20.4	3260	20.9	3294	21.3	3328	21.8	3362	22.3	3395	22.8	3429	23.3	3462	23.8	3494	24.3
	2000	3636	3147	21	3181	21.5	3216	22	3250	22.5	3283	23	3317	23.6	3350	24.1	3383	24.6	3415	25.1	3448	25.7	3480	26.2
	2200	4000	3146	22.6	3180	23.2	3213	23.7	3246	24.2	3279	24.8	3312	25.3	3345	25.9	3377	26.5	3409	27	3441	27.6	3472	28.1
	2400	4364	3151	24.4	3184	24.9	3217	25.5	3249	26.1	3282	26.6	3314	27.2	3345	27.8	3377	28.4	3409	29	3440	29.5	3471	30.1
	2600	4727	3161	26.1	3193	26.7	3226	27.3	3258	27.9	3289	28.5	3321	29.1	3352	29.7	3383	30.4	3414	31	3444	31.6	3475	32.2
	2800	5091	3176	28	3208	28.7	3239	29.3	3271	29.9	3302	30.5	3333	31.2	3363	31.8	3394	32.4	3424	33.1	3454	33.7	3484	34.4
	3000	5455	3195	30	3227	30.7	3257	31.3	3288	32	3319	32.6	3349	33.3	3379	33.9	3409	34.6	3438	35.3	3468	35.9	3497	36.6
3200	5818	3218	32.1	3249	32.8	3279	33.5	3309	34.1	3339	34.8	3369	35.5	3399	36.2	3428	36.9	3457	37.6	3486	38.3	3515	39	
3300	6000	3231	33.2	3261	33.9	3291	34.6	3321	35.3	3351	36	3380	36.7	3410	37.4	3439	38.1	3468	38.8	3496	39.5	3525	40.2	

Tamaño	CFM	VS	30"PE		32"PE		34"PE		35"PE		37"PE		39"PE		41"PE		43"PE		45"PE		46"PE		47"PE	
			RPM	BHP	RPM	BHP	RPM	BHP	RPM	BHP	RPM	BHP	RPM	BHP	RPM	BHP	RPM	BHP	RPM	BHP	RPM	BHP	RPM	BHP
1223	1500	1899	2873	10.6	2968	11.4	3060	12.2	3105	12.6	3194	13.4	3280	14.3	3365	15.1	3448	16	3529	16.8	3569	17.3	3608	17.7
	1700	2152	2875	11.7	2968	12.6	3059	13.4	3103	13.9	3191	14.7	3276	15.6	3360	16.5	3441	17.5	3521	18.4	3561	18.8	3600	19.3
	1900	2405	2882	12.9	2974	13.8	3063	14.7	3107	15.2	3193	16.1	3277	17.1	3359	18	3440	19	3519	20	3558	20.5	3596	21
	2100	2658	2894	14.1	2984	15.1	3072	16	3115	16.5	3200	17.5	3283	18.5	3364	19.6	3444	20.6	3521	21.6	3560	22.2	3598	22.7
	2300	2911	2911	15.4	2999	16.4	3086	17.5	3128	18	3212	19	3293	20.1	3373	21.2	3451	22.3	3528	23.4	3566	23.9	3604	24.5
	2500	3165	2932	16.8	3019	17.9	3104	19	3145	19.5	3227	20.6	3308	21.8	3386	22.9	3464	24	3539	25.2	3577	25.8	3614	26.4
	2700	3418	2957	18.2	3042	19.4	3126	20.5	3167	21.1	3247	22.3	3326	23.5	3404	24.7	3480	25.9	3554	27.1	3591	27.7	3627	28.3
	2900	3671	2987	19.8	3070	21	3152	22.2	3192	22.8	3271	24.1	3349	25.3	3425	26.6	3499	27.8	3573	29.1	3609	29.7	3645	30.4
	3100	3924	3020	21.5	3102	22.7	3182	24	3221	24.6	3299	25.9	3375	27.2	3449	28.5	3523	29.9	3595	31.2	3631	31.9	3666	32.5
	3300	4177	3057	23.3	3137	24.6	3215	25.9	3254	26.6	3330	27.9	3404	29.3	3478	30.7	3550	32	3621	33.4	3656	34.1	3691	34.8
	3500	4430	3097	25.2	3175	26.5	3252	27.9	3290	28.6	3364	30	3437	31.4	3509	32.9	3580	34.3	3650	35.7	3684	36.5	3719	37.2
	3700	4684	3140	27.2	3216	28.6	3291	30.1	3329	30.8	3402	32.3	3473	33.7	3544	35.2	3614	36.7	3682	38.2	3716	39	3750	39.7
3900	4937	3185	29.4	3260	30.9	3334	32.4	3370	33.1	3442	34.6	3512	36.2	3582	37.7	3650	39.3	3717	40.8	3750	41.6	3783	42.4	
4000	5063	3209	30.6	3283	32.1	3356	33.6	3392	34.4	3463	35.9	3533	37.4	3602	39	3669	40.6	3736	42.2	3769	43			

Tamaño	CFM	VS	43"PE		44"PE		45"PE		46"PE		47"PE		48"PE		49"PE		50"PE		51"PE		52"PE		53"PE	
			RPM	BHP	RPM	BHP	RPM	BHP	RPM	BHP	RPM	BHP	RPM	BHP	RPM	BHP	RPM	BHP	RPM	BHP	RPM	BHP	RPM	BHP
1224	1500	1899	3298	16.1	3337	16.6	3376	17	3414	17.5	3452	17.9	3489	18.4	3527	18.8	3563	19.3	3600	19.7	3636	20.2	3672	20.6
	1700	2152	3291	17.6	3330	18.1	3368	18.5	3405	19	3443	19.5	3480	20	3516	20.4	3553	20.9	3589	21.4	3625	21.9	3660	22.4
	1900	2405	3289	19.1	3327	19.6	3365	20.1	3402	20.6	3439	21.1	3476	21.6	3512	22.1	3548	22.6	3583	23.1	3619	23.7	3654	24.2
	2100	2658	3292	20.7	3330	21.2	3367	21.7	3404	22.3	3440	22.8	3476	23.3	3512	23.9	3547	24.4	3582	25	3617	25.5	3652	26.1
	2300	2911	3300	22.3	3337	22.9	3373	23.4	3409	24	3445	24.6	3481	25.1	3516	25.7	3551	26.3	3586	26.8	3620	27.4	3654	28
	2500	3165	3311	24.1	3347	24.7	3383	25.2	3419	25.8	3455	26.4	3490	27	3525	27.6	3559	28.2	3593	28.8	3627	29.4	3661	30
	2700	3418	3326	25.9	3362	26.5	3397	27.1	3433	27.7	3468	28.4	3502	29	3536	29.6	3571	30.2	3604	30.8	3638	31.5	3671	32.1
	2900	3671	3345	27.8	3380	28.4	3415	29.1	3450	29.7	3484	30.4	3518	31	3552	31.7	3586	32.3	3619	33	3652	33.7	3685	34.3
	3100	3924	3367	29.8	3402	30.5	3436	31.1	3470	31.8	3504	32.5	3538	33.2	3571	33.9	3604	34.5	3637	35.2	3669	35.9	3702	36.6
	3300	4177	3392	31.9	3427	32.6	3460	33.3	3494	34	3527	34.7	3560	35.4	3593	36.1	3626	36.9	3658	37.6	3690	38.3	3722	39
	3500	4430	3421	34.1	3455	34.9	3488	35.6	3521	36.3	3554	37.1	3586	37.8	3618	38.5	3650	39.3	3682	40	3714	40.8	3745	41.5
	3700	4684	3453	36.5	3486	37.3	3519	38	3551	38.8	3583	39.5	3615	40.3	3647	41.1	3678	41.8	3709	42.6	3740	43.4	3771	44.2
3900	4937	3488	39	3520	39.8	3552	40.6	3584	41.4	3615	42.1	3647	42.9	3678	43.7	3709	44.5	3740	45.3	3770	46.1			
4000	5063	3530	40.9	3538	41.1	3570	41.9	3601	42.7	3633	43.5	3664	44.3	3695	45.1	3725	45.9	3756	46.7	3786	47.6			

Tamaño	CFM	VS	48"PE		50"PE		51"PE		53"PE		54"PE		55"PE		56"PE		57"PE		58"PE		59"PE		60"PE	
			RPM	BHP	RPM	BHP	RPM	BHP	RPM	BHP	RPM	BHP	RPM	BHP	RPM	BHP	RPM	BHP	RPM	BHP	RPM	BHP	RPM	BHP
1225	1500	1899	3374	18.9	3447	19.8	3483	20.3	3554	21.3	3589	21.8	3624	22.3	3659	22.8	3693	23.3	3727	23.8	3761	24.3	3794	24.8
	1700	2152	3355	20.3	3427	21.3	3462	21.8	3532	22.9	3567	23.4	3602	23.9	3636	24.5	3669	25	3703	25.5	3736	26	3769	26.6
	2000	2532	3338	22.5	3408	23.6	3443	24.2	3511	25.3	3545	25.8	3579	26.4	3612	27	3645	27.5	3678	28.1	3711	28.7	3743	29.3
	2200	2785	3334	24.1	3403	25.2	3437	25.8	3504	26.9	3538	27.5	3571	28.1	3604	28.7	3636	29.3	3669	29.9	3701	30.5	3733	31.1
	2400	3038	3335	25.7	3403	26.9	3437	27.5	3503	28.7	3536	29.3	3568	29.9	3601	30.5	3633	31.1	3665	31.8	3696	32.4	3728	33
	2700	3418	3346	28.3	3412	29.6	3445	30.2	3510	31.5	3542	32.1	3573	32.8	3605	33.4	3636	34.1	3667	34.7	3698	35.4	3729	36.1



EVISA Modelo TURH-TURA Arr. 1 y 10

Tamaño	CFM	VS	54"PE		55"PE		56"PE		57"PE		58"PE		59"PE		60"PE		61"PE		62"PE		63"PE		64"PE			
			RPM	BHP	RPM	BHP	RPM	BHP	RPM	BHP	RPM	BHP	RPM	BHP	RPM	BHP	RPM	BHP	RPM	BHP	RPM	BHP	RPM	BHP	RPM	BHP
1226	1500	1899	3485	21.3	3519	21.8	3553	22.3	3587	22.7	3620	23.2	3654	23.7	3687	24.2	3719	24.6	3752	25.1	3784	25.6				
	1700	2152	3457	23.1	3491	23.6	3524	24.1	3558	24.6	3591	25.1	3624	25.7	3656	26.2	3688	26.7	3720	27.2	3752	27.7	3784	28.2		
	2000	2532	3428	25.8	3461	26.3	3494	26.9	3526	27.4	3559	28	3591	28.6	3622	29.1	3654	29.7	3685	30.3	3716	30.8	3747	31.4		
	2200	2785	3418	27.6	3450	28.2	3482	28.8	3514	29.4	3546	30	3577	30.5	3608	31.1	3639	31.7	3670	32.3	3701	32.9	3731	33.5		
	2400	3038	3415	29.5	3446	30.1	3478	30.7	3509	31.3	3540	32	3570	32.6	3601	33.2	3631	33.8	3661	34.4	3691	35.1	3721	35.7		
	2700	3418	3421	32.5	3452	33.1	3482	33.8	3512	34.4	3542	35.1	3572	35.7	3601	36.4	3631	37.1	3660	37.7	3689	38.4	3718	39.1		
	3000	3797	3439	35.7	3469	36.3	3498	37	3527	37.7	3556	38.4	3585	39.1	3614	39.8	3643	40.5	3671	41.2	3699	41.9	3727	42.6		
	3200	4051	3456	37.9	3485	38.6	3514	39.3	3543	40.1	3571	40.8	3600	41.5	3628	42.2	3656	42.9	3684	43.7	3712	44.4	3739	45.1		
	3400	4304	3477	40.3	3505	41	3534	41.8	3562	42.5	3590	43.2	3618	44	3646	44.8	3673	45.5	3701	46.3	3728	47	3755	47.8		
	3600	4557	3500	42.8	3528	43.5	3556	44.3	3584	45.1	3612	45.8	3639	46.6	3667	47.4	3694	48.2	3721	49	3747	49.7	3774	50.5		
	3800	4810	3526	45.4	3554	46.2	3581	47	3609	47.8	3636	48.6	3663	49.4	3690	50.2	3717	51	3743	51.8	3770	52.6	3796	53.4		
	4000	5063	3554	48.2	3581	49	3608	49.8	3636	50.6	3663	51.5	3689	52.3	3716	53.1	3742	53.9	3769	54.8	3795	55.6				
4300	5443	3598	52.6	3625	53.4	3652	54.3	3679	55.1	3705	56	3732	56.9	3758	57.7	3784	58.6									
4500	5696	3630	55.7	3656	56.6	3683	57.5	3710	58.4	3736	59.2	3762	60.1	3788	61											

Como usar las Tablas de Capacidad Arreglos 4 y 4V

PASO	PROCEDIMIENTO	EJEMPLO
1	Para un volumen, presión, RPM conocido, las tablas de capacidad se utilizan para conocer tamaños, recortes del rotor, y BHP. Si la capacidad es a condiciones distintas a 70° F y nivel del mar o densidad estándar (0.0750 lb/pie3), los factores de corrección deben aplicarse a presión estática y BHP.	Se requiere un ventilador a 3500 rpm para una presión de 25" C.A., a 350° F y una altitud sobre el nivel del mar de 5000 pies.
2	Si se requieren correcciones por temperatura altitud o densidad, determine los factores de corrección utilizando las tablas de factores de corrección.	Factor de corrección para 350° F es 1.53 Factor de corrección para 5000 pies es 1.20 Factor de corrección para -25" es 1.07 Factor final = 1.53 x 1.20 x 1.07 = 1.96
3	Multiplique las condiciones operativas PE por los factores de corrección. Esto proporciona la PE equivalente a la densidad de 0.0750 lb/pie3.	La PE requerida por el ventilador con aire estándar es: 25.0" x 1.96= 49" C.A.
4	Seleccione el ventilador, tamaño, recorte y BHP de las tablas de capacidad, NOTA: para un desempeño dado, los ventiladores más grandes son generalmente más eficientes y tendrán menor costo de operación en la vida útil del ventilador.	Un turboventilador TURH 825 a 3500 rpm, 49" C.A., 1784 CFM y 22.3 BHP con aire estándar (0.0750 lb/pie3)
5	Determine el BHP operativo al dividir BHP de las tablas de capacidad entre el factor de corrección utilizado en el paso 3.	BHP operativo es 22.3 / 1.96 = 11.37 BHP



EVISA Modelo TURH-TURA Arr. 4 y 4V

414	RPM	10 1/2"PE	11"PE	11 1/2"PE	12"PE	12 1/2"PE	13"PE	13 1/2"PE	14"PE	15"PE	16"PE	17"PE
		CFM BHP	CFM BHP	CFM BHP	CFM BHP	CFM BHP	CFM BHP	CFM BHP	CFM BHP	CFM BHP	CFM BHP	CFM BHP
	3500	689 2.94	663 2.88	637 2.81	610 2.73	584 2.65	556 2.57	526 2.47	494 2.37	421 2.13	325 1.82	176 1.34
415	RPM	13"PE	13 1/2"PE	14"PE	14 1/2"PE	15"PE	15 1/2"PE	16"PE	16 1/2"PE	17"PE	18"PE	19"PE
		CFM BHP	CFM BHP	CFM BHP	CFM BHP	CFM BHP	CFM BHP	CFM BHP	CFM BHP	CFM BHP	CFM BHP	CFM BHP
	3500	695 3.37	671 3.29	647 3.21	623 3.12	599 3.03	573 2.94	545 2.84	515 2.72	481 2.6	392 2.26	205 1.56
416	RPM	15 1/2"PE	16"PE	16 1/2"PE	17"PE	17 1/2"PE	18"PE	18 1/2"PE	19"PE	19 1/2"PE	20"PE	20 1/2"PE
		CFM BHP	CFM BHP	CFM BHP	CFM BHP	CFM BHP	CFM BHP	CFM BHP	CFM BHP	CFM BHP	CFM BHP	CFM BHP
	3500	679 3.61	656 3.51	631 3.42	605 3.31	578 3.2	548 3.08	515 2.94	477 2.78	432 2.59	373 2.34	276 1.95
417	RPM	18"PE	18 1/2"PE	19"PE	19 1/2"PE	20"PE	20 1/2"PE	20 3/4"PE	21"PE	21 1/2"PE	21 3/4"PE	22"PE
		CFM BHP	CFM BHP	CFM BHP	CFM BHP	CFM BHP	CFM BHP	CFM BHP	CFM BHP	CFM BHP	CFM BHP	CFM BHP
	3500	688 3.86	663 3.75	637 3.64	609 3.51	578 3.37	543 3.21	523 3.11	501 3.01	448 2.75	415 2.59	374 2.39
418	RPM	20"PE	20 1/2"PE	20 3/4"PE	21"PE	21 1/2"PE	21 3/4"PE	22"PE	22 3/4"PE	23"PE	23 1/2"PE	23 3/4"PE
		CFM BHP	CFM BHP	CFM BHP	CFM BHP	CFM BHP	CFM BHP	CFM BHP	CFM BHP	CFM BHP	CFM BHP	CFM BHP
	3500	693 4.47	668 4.35	654 4.28	641 4.21	611 4.06	594 3.98	577 3.89	515 3.58	490 3.45	426 3.12	381 2.88
419	RPM	25 1/2"PE	25 3/4"PE	26"PE	26 1/2"PE	26 3/4"PE	27"PE	27 1/2"PE	28"PE	28 1/2"PE	28 3/4"PE	29"PE
		CFM BHP	CFM BHP	CFM BHP	CFM BHP	CFM BHP	CFM BHP	CFM BHP	CFM BHP	CFM BHP	CFM BHP	CFM BHP
	3500	689 5.4	674 5.31	659 5.23	626 5.04	609 4.94	591 4.83	551 4.59	504 4.32	442 3.96	399 3.72	312 3.23
420	RPM	28 3/4"PE	29"PE	29 1/2"PE	29 3/4"PE	30"PE	30 1/2"PE	30 3/4"PE	30 1/2"PE	30 3/4"PE	31"PE	31 1/2"PE
		CFM BHP	CFM BHP	CFM BHP	CFM BHP	CFM BHP	CFM BHP	CFM BHP	CFM BHP	CFM BHP	CFM BHP	CFM BHP
	3500	686 5.81	669 5.7	633 5.47	613 5.34	592 5.21	546 4.92	519 4.76	546 4.92	519 4.76	489 4.57	400 4.02
421	RPM	30 3/4"PE	31"PE	31 1/4"PE	31 1/2"PE	31 3/4"PE	32"PE	32 1/4"PE	32 1/2"PE	32 3/4"PE	33"PE	33 1/8"PE
		CFM BHP	CFM BHP	CFM BHP	CFM BHP	CFM BHP	CFM BHP	CFM BHP	CFM BHP	CFM BHP	CFM BHP	CFM BHP
	3500	699 6.44	680 6.3	660 6.16	640 6.01	617 5.85	593 5.68	566 5.5	535 5.29	498 5.04	448 4.7	410 4.46
422	RPM	32 1/2"PE	32 3/4"PE	33"PE	33 1/4"PE	33 1/2"PE	33 3/4"PE	34"PE	34 1/4"PE	34 1/2"PE	34 3/4"PE	35"PE
		CFM BHP	CFM BHP	CFM BHP	CFM BHP	CFM BHP	CFM BHP	CFM BHP	CFM BHP	CFM BHP	CFM BHP	CFM BHP
	3500	778 7.69	765 7.6	752 7.5	735 7.37	722 7.28	702 7.13	687 7.01	664 6.84	640 6.66	611 6.43	573 6.14
614	RPM	11"PE	11 1/2"PE	12"PE	12 1/2"PE	13"PE	13 1/2"PE	14"PE	14 1/2"PE	15"PE	15 1/2"PE	16"PE
		CFM BHP	CFM BHP	CFM BHP	CFM BHP	CFM BHP	CFM BHP	CFM BHP	CFM BHP	CFM BHP	CFM BHP	CFM BHP
	3500	1317 4.68	1273 4.57	1222 4.42	1163 4.24	1097 4.03	1023 3.8	943 3.55	859 3.29	770 3.02	670 2.73	536 2.35
615	RPM	14 1/2"PE	15"PE	15 1/4"PE	15 1/2"PE	15 3/4"PE	16"PE	16 1/2"PE	17"PE	17 1/2"PE	18"PE	18 1/2"PE
		CFM BHP	CFM BHP	CFM BHP	CFM BHP	CFM BHP	CFM BHP	CFM BHP	CFM BHP	CFM BHP	CFM BHP	CFM BHP
	3500	1281 5.3	1226 5.11	1198 5.02	1168 4.92	1138 4.82	1107 4.71	1040 4.48	964 4.22	874 3.9	758 3.49	561 2.8
616	RPM	17"PE	17 1/2"PE	18"PE	18 1/2"PE	19"PE	19 1/2"PE	20"PE	20 1/4"PE	20 1/2"PE	20 3/4"PE	21"PE
		CFM BHP	CFM BHP	CFM BHP	CFM BHP	CFM BHP	CFM BHP	CFM BHP	CFM BHP	CFM BHP	CFM BHP	CFM BHP
	3500	1338 6.16	1283 5.95	1225 5.74	1162 5.5	1093 5.24	1015 4.94	923 4.58	868 4.36	804 4.11	722 3.78	577 3.2



EVISA Modelo TURH-TURA Arr. 4 y 4V

617	RPM	19 1/2"PE	19 3/4"PE	20"PE	20 1/4"PE	20 1/2"PE	20 3/4"PE	21"PE	21 1/4"PE	21 1/2"PE	22"PE	22 1/2"PE
		CFM BHP	CFM BHP	CFM BHP	CFM BHP	CFM BHP	CFM BHP	CFM BHP	CFM BHP	CFM BHP	CFM BHP	CFM BHP
	3500	1334 19.5	1304 19.8	1273 6.58	1234 6.41	1207 6.29	1165 6.12	1137 5.99	1092 5.8	1061 5.66	972 5.28	857 4.78
618	RPM	22 1/4"PE	22 1/2"PE	22 3/4"PE	23"PE	23 1/4"PE	23 1/2"PE	24"PE	24 1/2"PE	25"PE	25 1/2"PE	25 3/4"PE
		CFM BHP	CFM BHP	CFM BHP	CFM BHP	CFM BHP	CFM BHP	CFM BHP	CFM BHP	CFM BHP	CFM BHP	CFM BHP
	3500	1583 9.11	1561 9	1536 8.87	1518 8.78	1490 8.63	1470 8.53	1413 8.25	1325 7.82	1129 6.91	947 6.04	797 5.3
619	RPM	20 1/2"PE	21"PE	22"PE	23"PE	24"PE	25"PE	26"PE	27"PE	28"PE	29"PE	29 1/2"PE
		CFM BHP	CFM BHP	CFM BHP	CFM BHP	CFM BHP	CFM BHP	CFM BHP	CFM BHP	CFM BHP	CFM BHP	CFM BHP
	3500	1334 8.88	1308 8.74	1252 8.44	1192 8.11	1127 7.77	1057 7.4	981 6.98	896 6.52	798 5.97	672 5.25	578 4.72
620	RPM	24 1/2"PE	25"PE	26"PE	27"PE	28"PE	29"PE	30"PE	30 1/2"PE	31"PE	32"PE	32 1/2"PE
		CFM BHP	CFM BHP	CFM BHP	CFM BHP	CFM BHP	CFM BHP	CFM BHP	CFM BHP	CFM BHP	CFM BHP	CFM BHP
	3500	1317 9.72	1289 9.55	1229 9.19	1164 8.8	1093 8.37	1015 7.88	925 7.32	873 7	815 6.63	646 5.58	550 4.98
621	RPM	27 1/2"PE	28"PE	28 1/2"PE	29"PE	29 1/2"PE	30"PE	31"PE	32"PE	33"PE	34"PE	34 1/2"PE
		CFM BHP	CFM BHP	CFM BHP	CFM BHP	CFM BHP	CFM BHP	CFM BHP	CFM BHP	CFM BHP	CFM BHP	CFM BHP
	3500	1304 10.6	1274 10.3	1243 10.1	1210 9.91	1176 9.69	1141 9.45	1064 8.94	978 8.35	875 7.64	727 6.6	856 7.82
622	RPM	30 1/2"PE	31"PE	32"PE	33"PE	34"PE	34 1/2"PE	35"PE	35 1/2"PE	36"PE	36 1/2"PE	37"PE
		CFM BHP	CFM BHP	CFM BHP	CFM BHP	CFM BHP	CFM BHP	CFM BHP	CFM BHP	CFM BHP	CFM BHP	CFM BHP
	3500	1323 11.7	1292 11.4	1227 10.9	1158 10.4	1082 9.84	1040 9.54	994 9.21	944 8.85	885 8.44	811 7.9	662 6.8
623	RPM	41 1/4"PE	41 1/2"PE	41 3/4"PE	42"PE	45 1/4"PE	42 1/2"PE	42 3/4"PE	43"PE	43 1/4"PE	43 1/2"PE	43 3/4"PE
		CFM BHP	CFM BHP	CFM BHP	CFM BHP	CFM BHP	CFM BHP	CFM BHP	CFM BHP	CFM BHP	CFM BHP	CFM BHP
	3500	1341 15.5	1326 15.3	1310 15.2	1292 15	1273 14.8	1250 14.6	1224 14.3	1192 14	1153 13.7	1099 13.2	1012 12.4
624	RPM	42"PE	42 1/2"PE	43"PE	43 1/2"PE	44"PE	44 1/2"PE	45"PE	45 1/2"PE	46"PE	47"PE	47 1/2"PE
		CFM BHP	CFM BHP	CFM BHP	CFM BHP	CFM BHP	CFM BHP	CFM BHP	CFM BHP	CFM BHP	CFM BHP	CFM BHP
	3500	1683 20.4	1653 20.1	1622 19.8	1590 19.6	1556 19.2	1519 18.9	1480 18.5	1436 18	1385 17.4	1225 15.8	1112 14.7
625	RPM	43 1/2"PE	44"PE	44 1/2"PE	45"PE	45 1/2"PE	46"PE	46 1/2"PE	47"PE	47 1/2"PE	48"PE	48 1/2"PE
		CFM BHP	CFM BHP	CFM BHP	CFM BHP	CFM BHP	CFM BHP	CFM BHP	CFM BHP	CFM BHP	CFM BHP	CFM BHP
	3500	1848 23.5	1822 23.2	1794 22.9	1765 22.5	1734 22.2	1700 21.8	1663 21.4	1622 20.9	1576 20.4	1524 19.9	1465 19.5
626	RPM	46"PE	46 1/2"PE	47"PE	47 1/2"PE	48"PE	48 1/2"PE	49"PE	49 1/2"PE	50"PE	51"PE	52"PE
		CFM BHP	CFM BHP	CFM BHP	CFM BHP	CFM BHP	CFM BHP	CFM BHP	CFM BHP	CFM BHP	CFM BHP	CFM BHP
	3500	1992 27.3	1959 26.9	1926 26.5	1892 26.1	1856 25.7	1820 25.3	1783 24.8	1744 24.3	1703 23.8	1613 22.8	1503 21.6
815	RPM	9"PE	10"PE	11"PE	12"PE	13"PE	14"PE	15"PE	16"PE	17"PE	18"PE	18 1/2"PE
		CFM BHP	CFM BHP	CFM BHP	CFM BHP	CFM BHP	CFM BHP	CFM BHP	CFM BHP	CFM BHP	CFM BHP	CFM BHP
	3500	2197 8.54	2094 8.13	1992 7.75	1888 7.37	1779 6.98	1661 6.58	1531 6.13	1383 5.62	1203 5	955 4.13	747 3.4
816	RPM	11 1/2"PE	12"PE	13"PE	14"PE	15"PE	16"PE	17"PE	18"PE	19"PE	20"PE	21"PE
		CFM BHP	CFM BHP	CFM BHP	CFM BHP	CFM BHP	CFM BHP	CFM BHP	CFM BHP	CFM BHP	CFM BHP	CFM BHP
	3500	2431 10.3	2320 9.96	2167 9.44	2038 8.96	1917 8.5	1796 8.02	1670 7.52	1532 6.97	1375 6.34	1179 5.57	859 4.31



EVISA Modelo TURH-TURA Arr. 4 y 4V

817	RPM	13"PE	14"PE	15"PE	16"PE	17"PE	18"PE	19"PE	20"PE	21"PE	22"PE	23"PE
		CFM BHP	CFM BHP	CFM BHP	CFM BHP	CFM BHP	CFM BHP	CFM BHP	CFM BHP	CFM BHP	CFM BHP	CFM BHP
	3500	2342 11.2	2268 10.9	2184 10.5	2091 10	1985 9.53	1867 8.98	1735 8.39	1588 7.74	1421 7.03	1218 6.17	869 4.69
818	RPM	16 1/2"PE	17"PE	18"PE	19"PE	20"PE	21"PE	22"PE	23"PE	24"PE	25"PE	25 1/2"PE
		CFM BHP	CFM BHP	CFM BHP	CFM BHP	CFM BHP	CFM BHP	CFM BHP	CFM BHP	CFM BHP	CFM BHP	CFM BHP
	3500	2410 13.4	2367 13.2	2274 12.7	2169 12.1	2054 11.5	1928 10.8	1791 10.1	1643 9.34	1476 8.53	1272 7.57	1132 6.92
819	RPM	25"PE	25 1/2"PE	26"PE	26 1/2"PE	27"PE	27 1/2"PE	28"PE	28 1/2"PE	29"PE	29 1/2"PE	30"PE
		CFM BHP	CFM BHP	CFM BHP	CFM BHP	CFM BHP	CFM BHP	CFM BHP	CFM BHP	CFM BHP	CFM BHP	CFM BHP
	3500	2344 15.2	2271 14.8	2195 14.3	2115 13.9	2031 13.4	1941 12.9	1845 12.3	1740 11.7	1621 11	1479 10.2	1278 9.02
820	RPM	27 3/4"PE	28"PE	28 1/2"PE	29"PE	29 1/2"PE	30"PE	30 1/2"PE	31"PE	31 1/2"PE	32"PE	32 1/2"PE
		CFM BHP	CFM BHP	CFM BHP	CFM BHP	CFM BHP	CFM BHP	CFM BHP	CFM BHP	CFM BHP	CFM BHP	CFM BHP
	3500	2432 17.5	2396 17.2	2322 16.7	2245 16.2	2164 15.6	2079 15.1	1988 14.4	1890 13.8	1781 13.1	1655 12.3	1492 11.3
821	RPM	31 3/4"PE	32"PE	32 1/2"PE	33"PE	33 1/2"PE	34"PE	34 1/2"PE	35"PE	35 1/2"PE	36"PE	36 1/4"PE
		CFM BHP	CFM BHP	CFM BHP	CFM BHP	CFM BHP	CFM BHP	CFM BHP	CFM BHP	CFM BHP	CFM BHP	CFM BHP
	3500	2423 18.6	2388 18.4	2317 17.9	2244 17.4	2167 16.9	2086 16.4	1999 15.8	1902 15.2	1789 14.5	1644 13.5	1537 12.8
822	RPM	34 1/2"PE	35"PE	35 1/2"PE	36"PE	36 1/2"PE	37"PE	37 1/2"PE	38"PE	38 1/2"PE	39"PE	39 1/2"PE
		CFM BHP	CFM BHP	CFM BHP	CFM BHP	CFM BHP	CFM BHP	CFM BHP	CFM BHP	CFM BHP	CFM BHP	CFM BHP
	3500	2449 20.6	2383 20.1	2316 19.6	2247 19.1	2176 18.7	2101 18.2	2021 17.6	1934 17	1836 16.4	1717 15.6	1533 14.2
823	RPM	34"PE	35"PE	36"PE	37"PE	38"PE	39"PE	40"PE	41"PE	42"PE	43"PE	44"PE
		CFM BHP	CFM BHP	CFM BHP	CFM BHP	CFM BHP	CFM BHP	CFM BHP	CFM BHP	CFM BHP	CFM BHP	CFM BHP
	3500	2438 24.7	2359 24	2279 23.3	2197 22.6	2112 21.8	2023 21.1	1927 20.2	1821 19.3	1702 18.3	1559 17	1365 15.3
824	RPM	39"PE	40"PE	41"PE	42"PE	43"PE	44"PE	45"PE	46"PE	47"PE	48"PE	48 1/2"PE
		CFM BHP	CFM BHP	CFM BHP	CFM BHP	CFM BHP	CFM BHP	CFM BHP	CFM BHP	CFM BHP	CFM BHP	CFM BHP
	3500	2432 25.2	2358 24.5	2281 23.8	2199 23	2111 22.2	2015 21.2	1907 20.2	1784 19	1631 17.5	1411 15.4	1183 13.2
825	RPM	43"PE	44"PE	45"PE	45 1/2"PE	46"PE	47"PE	48"PE	49"PE	50"PE	50 1/2"PE	51"PE
		CFM BHP	CFM BHP	CFM BHP	CFM BHP	CFM BHP	CFM BHP	CFM BHP	CFM BHP	CFM BHP	CFM BHP	CFM BHP
	3500	2412 28.7	2331 27.9	2242 27	2195 26.5	2145 26	2038 24.9	1920 23.7	1784 22.3	1620 20.6	1516 19.6	1373 18.1
826	RPM	47"PE	47 1/2"PE	48"PE	49"PE	50"PE	50 1/2"PE	51"PE	52"PE	53"PE	53 1/2"PE	54"PE
		CFM BHP	CFM BHP	CFM BHP	CFM BHP	CFM BHP	CFM BHP	CFM BHP	CFM BHP	CFM BHP	CFM BHP	CFM BHP
	3500	2425 31.2	2385 30.9	2344 30.4	2257 29.5	2163 28.5	2112 27.9	2058 27.3	1940 25.9	1799 24.4	1715 23.4	1611 22.3
1019	RPM	20"PE	21"PE	22"PE	23"PE	24"PE	25"PE	26"PE	27"PE	28"PE	29"PE	30"PE
		CFM BHP	CFM BHP	CFM BHP	CFM BHP	CFM BHP	CFM BHP	CFM BHP	CFM BHP	CFM BHP	CFM BHP	CFM BHP
	3500	3011 19.2	2913 18.5	2810 17.9	2702 17.2	2586 16.5	2461 15.7	2323 14.9	2168 14	1985 12.9	1753 11.6	1377 9.5
1020	RPM	23"PE	24"PE	25"PE	26"PE	27"PE	28"PE	29"PE	30"PE	31"PE	32"PE	33"PE
		CFM BHP	CFM BHP	CFM BHP	CFM BHP	CFM BHP	CFM BHP	CFM BHP	CFM BHP	CFM BHP	CFM BHP	CFM BHP
	3500	3071 21.6	2972 20.9	2867 20.1	2754 19.3	2634 18.5	2503 17.6	2362 16.7	2204 15.6	2023 14.5	1800 13.1	1435 10.9



EVISA Modelo TURH-TURA Arr. 4 y 4V

1021	RPM	10 1/2"PE	11"PE	11 1/2"PE	12"PE	12 1/2"PE	13"PE	13 1/2"PE	14"PE	15"PE	16"PE	17"PE
		CFM BHP	CFM BHP	CFM BHP	CFM BHP	CFM BHP	CFM BHP	CFM BHP	CFM BHP	CFM BHP	CFM BHP	CFM BHP
	3500	3577 27.6	3421 26.5	3335 25.8	3146 24.3	2929 22.6	2808 21.7	2534 19.6	2378 18.5	2204 17.3	1999 15.9	1724 14.1
1022	RPM	26"PE	28"PE	30"PE	32"PE	34"PE	35"PE	36"PE	37"PE	38"PE	39"PE	39 1/2"PE
		CFM BHP	CFM BHP	CFM BHP	CFM BHP	CFM BHP	CFM BHP	CFM BHP	CFM BHP	CFM BHP	CFM BHP	CFM BHP
	3500	3548 29.6	3368 28.1	3156 26.2	2918 24.2	2658 22.1	2519 21.1	2373 20	2214 18.9	2031 17.6	1791 15.9	1580 14.4
1023	RPM	36"PE	37"PE	38"PE	38 1/2"PE	39"PE	40"PE	40 1/2"PE	41"PE	42"PE	43"PE	44"PE
		CFM BHP	CFM BHP	CFM BHP	CFM BHP	CFM BHP	CFM BHP	CFM BHP	CFM BHP	CFM BHP	CFM BHP	CFM BHP
	3500	4216 38.6	4091 37.7	3946 36.5	3862 35.9	3773 35.2	3583 33.6	3480 32.8	3370 31.8	3122 29.8	2820 27.2	2403 23.7
1024	RPM	39"PE	40"PE	40 1/2"PE	41"PE	42"PE	43"PE	44"PE	45"PE	46"PE	47"PE	48"PE
		CFM BHP	CFM BHP	CFM BHP	CFM BHP	CFM BHP	CFM BHP	CFM BHP	CFM BHP	CFM BHP	CFM BHP	CFM BHP
	3500	4505 44.3	4395 43.4	4335 42.9	4271 42.3	4129 41.2	3969 39.9	3788 38.3	3585 36.6	3352 34.6	3069 32.1	2679 28.7
1025	RPM	44"PE	45"PE	46"PE	47"PE	48"PE	49"PE	50"PE	51"PE	52"PE	52 1/2"PE	53"PE
		CFM BHP	CFM BHP	CFM BHP	CFM BHP	CFM BHP	CFM BHP	CFM BHP	CFM BHP	CFM BHP	CFM BHP	CFM BHP
	3500	4581 48.7	4440 47.4	4283 45.9	4111 44.3	3932 42.7	3745 41	3541 39.1	3308 37	3018 34.4	2824 32.6	2497 29.6
1026	RPM	46"PE	47"PE	48"PE	49"PE	50"PE	51"PE	52"PE	53"PE	54"PE	55"PE	56"PE
		CFM BHP	CFM BHP	CFM BHP	CFM BHP	CFM BHP	CFM BHP	CFM BHP	CFM BHP	CFM BHP	CFM BHP	CFM BHP
	3500	4891 46.1	4751 54.2	4606 52.7	4456 51.1	4299 49.4	4135 47.7	3963 45.9	3777 44.2	3573 42.2	3338 40	3040 37.1
1223	RPM	34"PE	35"PE	36"PE	37"PE	38"PE	39"PE	40"PE	41"PE	42"PE	43"PE	44"PE
		CFM BHP	CFM BHP	CFM BHP	CFM BHP	CFM BHP	CFM BHP	CFM BHP	CFM BHP	CFM BHP	CFM BHP	CFM BHP
	3500	4603 41.7	4465 40.5	4321 39.3	4171 38.1	4012 36.8	3841 35.4	3655 33.9	3447 32.2	3207 30.3	2911 27.9	2486 24.5
1224	RPM	39"PE	40"PE	41"PE	42"PE	43"PE	44"PE	45"PE	46"PE	47"PE	47 1/2"PE	48"PE
		CFM BHP	CFM BHP	CFM BHP	CFM BHP	CFM BHP	CFM BHP	CFM BHP	CFM BHP	CFM BHP	CFM BHP	CFM BHP
	3500	4649 45.9	4504 44.7	4351 43.3	4187 41.9	4009 40.3	3816 38.7	3601 36.8	3352 34.6	3069 32.1	2875 30.5	2640 28.4
1225	RPM	42"PE	43"PE	44"PE	45"PE	46"PE	47"PE	48"PE	49"PE	50"PE	51"PE	52"PE
		CFM BHP	CFM BHP	CFM BHP	CFM BHP	CFM BHP	CFM BHP	CFM BHP	CFM BHP	CFM BHP	CFM BHP	CFM BHP
	3500	4962 53	4830 51.6	4691 50.2	4546 48.8	4393 47.2	4230 45.6	4055 43.9	3864 42.1	3650 40	3399 37.7	3076 34.7
1226	RPM	46"PE	47"PE	48"PE	49"PE	50"PE	51"PE	52"PE	53"PE	54"PE	55"PE	56"PE
		CFM BHP	CFM BHP	CFM BHP	CFM BHP	CFM BHP	CFM BHP	CFM BHP	CFM BHP	CFM BHP	CFM BHP	CFM BHP
	3500	5012 57	4862 55.4	4706 53.7	4543 52	4374 50.3	4197 48.5	4011 46.7	3813 44.8	3596 42.7	3347 40.4	3023 37.3

DIMENSIONES

Dia. Rotor	A		C	D	F	G	K		N		S		T			U		V		W	
	Arr. 8	Arr. 10					Arr. 10	Arr. 10	Arr. 10	Arr. 4	Arr. 8	Arr. 10	Arr. 4	Arr. 8	Arr. 10	Arr. 4	Arr. 8	Arr. 10	Arr. 10	Arr. 10	Arr. 10
14-18	19 1/2	21	13 5/8	11 3/4	14 3/8	12 3/4	3 1/2	22	17 3/8	8 7/8	9 1/8	9 3/8	9 3/4	10	8 1/4	10 1/4					
19-22	23 5/8	27 5/8	16 1/2	14 7/8	17 1/2	15 1/2	4 1/2	26	19 7/8	10 7/8	10 7/8	12 1/4	11 3/4	11 3/4	11	13					
23-26	26 5/8	27 5/8	19 1/2	17 5/8	20 5/8	18 1/4	4 1/2	26	19 7/8	10 7/8	10 7/8	12 1/4	11 3/4	11 3/4	11	13					

Dia. Rotor	Dia. Descarga	Dia. Succión	Almacén Motor Arr. 4, 8	A Arr. 4	B	H Arreglo			JJ	K Arr. 8	L	M	NN Arr. 8	R Arreglo		S Arreglo	
						4	8	10						4, 8	10	4	8
						14-18	04	6						143-145	17 3/4	18 1/4	19
182-184	19	24 1/2	41 7/8	33 1/8	14 1/8	16 1/2											
19-22	04	6	143-145	23	17 3/4	25	39 7/8	36 1/8	6 1/8	3 3/8	6 5/8	3 7/8	31 7/8	3 3/8	5 1/8	14 1/8	15
182-184			24	42 1/2		33 3/8	14 1/8	16 1/2									
14-18	06	8	143-145	17 3/4	18 1/4	21 3/8	41 7/8	33 1/2	6 3/4	3 3/8	8 5/8	6 1/4	33	4 1/2	5 1/2	8 5/8	15
182-184			19	26 7/8		44 3/8	33 1/2	34 1/2								16 1/2	
19-22	06	6	143-145	23	17 3/4	25	39 7/8	36 1/8	6 1/8	3 3/8	6 5/8	3 7/8	31 7/8	3 3/8	5 1/8	14 1/8	16 1/2
182-184			24	42 1/2		33 3/8	14 1/8	16 1/2									
23-26	06	8	182-184	24	19	26 1/2	44 1/2	37 5/8	7	3 7/8	8 5/8	5	34 3/8	3 7/8	5 5/8	14 1/8	17
213-215			24 3/4	47 5/8		37 5/8	36 5/8	19 1/4									
254-256	26	31 7/8	51 7/8	37 5/8	7	3 1/4	8 5/8	5	36 5/8	3 7/8	5 5/8	42	19 1/2	24 5/8	25 3/8		
15-18	08	8	182-184	19	18 1/4	26 7/8	44 3/8	33 1/8	6 3/4	3 3/8	8 5/8	6 1/4	34 1/2	4 1/2	5 1/2	14 1/8	16 1/2
213-215			19 3/4	47 1/2		33 1/8	36 3/4	18 3/4									
19-22	08	8	182-184	24	17 3/4	26 7/8	44 3/8	38	6 3/4	3 3/8	8 5/8	6 1/4	34 1/2	4 1/2	6 1/4	14 1/8	16 1/2
213-215			24 3/4	47 1/2		38	36 3/4	18 3/4									
23-26	08	8	254-256	26	19	32 1/4	51 3/4	37 5/8	7	2 7/8	8 5/8	5	42 1/8	3 7/8	5 5/8	19 1/2	24 1/8
213-215			24 3/4	26 1/2		47 5/8	37 5/8	7								36 5/8	14 1/8
254-256	26	31 7/8	51 7/8	37 5/8	7	3 1/4	8 5/8	5	42	3 7/8	5 5/8	42 3/4	19 1/2	24 5/8	25 3/8		
284-286	26 3/4	31 7/8	53	37 5/8	7	3 1/4	8 5/8	5	42 3/4	3 7/8	5 5/8	42 3/4	19 1/2	24 5/8	25 3/8		
19-22	10	10	213-215	24 3/4	21 3/4	26 7/8	47 1/2	38	6 3/4	2 7/8	8 5/8	6 1/4	36 3/4	4 1/2	6 1/4	14 1/8	18 3/4
254-256			26	32 1/4		51 3/4	38	6 3/4								2 7/8	8 5/8
284-286	26 3/4	32 1/4	54 3/8	39	7 1/4	3 1/4	10 3/4	7 1/4	42 7/8	5	6 3/4	43 1/8	19 1/2	24 5/8	25 3/8		
254-256	26	33 1/4	53 1/4	39	7 1/4	3 1/4	10 3/4	7 1/4	43 1/8	5	6 3/4	43 7/8	19 1/2	24 5/8	25 3/8		
284-286	26 3/4	37 1/4	56 7/8	39	7 1/4	3 1/4	10 3/4	7 1/4	43 7/8	5	6 3/4	46 3/8	23 1/2	27 7/8	27 7/8		
324-326	29 1/4	37 1/4	56 7/8	39	7 1/4	3 1/4	10 3/4	7 1/4	46 3/8	5	6 3/4	46 3/8	23 1/2	27 7/8	27 7/8		
284-286	28 1/4	37 1/4	54 3/8	39	7 1/4	3 1/4	10 3/4	7 1/4	43 7/8	5	6 3/4	43 7/8	23 1/2	27 7/8	27 7/8		
324-326	29 1/4	37 1/4	56 7/8	39	7 1/4	3 1/4	10 3/4	7 1/4	46 3/8	5	6 3/4	46 3/8	23 1/2	27 7/8	27 7/8		

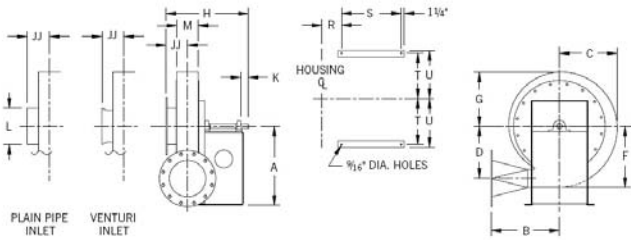

Arreglo 4

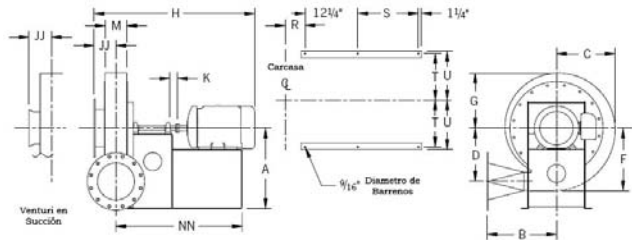

Arreglo 8

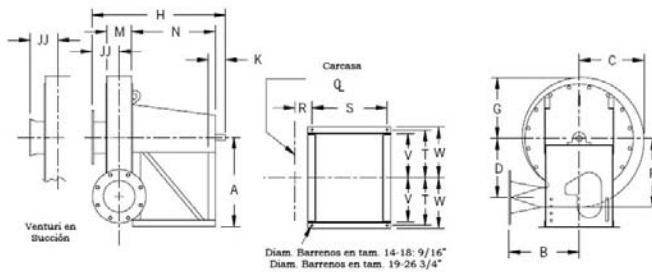

Arreglo 10

Las carcasas son reversibles y rotables en 22.5° excepto en descargas DB y BAU ya que requieren una construcción especial.

En el Arreglo 10 los tamaños del 19 al 22 no son rotables.

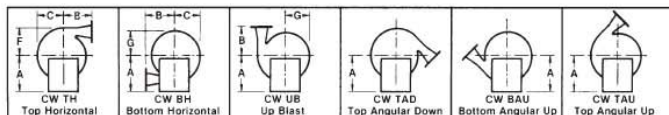

Con el Reloj con descarga angular a 45°

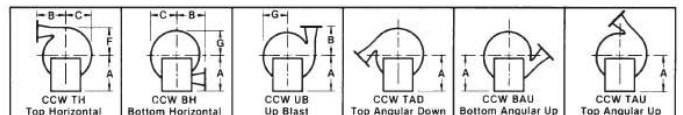

Contra el Reloj con descarga angular a 45°

DIMENSIONES Arreglo 4V

DIMENSIONES [PULGADAS]

DIA. ROTOR	DESCARGA	SUCCION	B	C	D	F	G	JJ	M
14-18	04	06	18 1/4	13 5/8	11 3/4	14 3/8	12 3/4	5 5/8	3 7/8
	06	08						6 3/4	6 1/4
	08								
19-22	04	06	17 3/4	16 1/2	14 7/8	17 1/2	15 1/2	6 1/8	3 7/8
	06								
	08	08	6 3/4					6 1/4	
	10		21 3/4						
23-26	04	06	19	19 1/2	17 5/8	20 5/8	18 1/4	7	5
	06	08							
	08		23						
	10								
	12	12						7 1/4	7 1/4

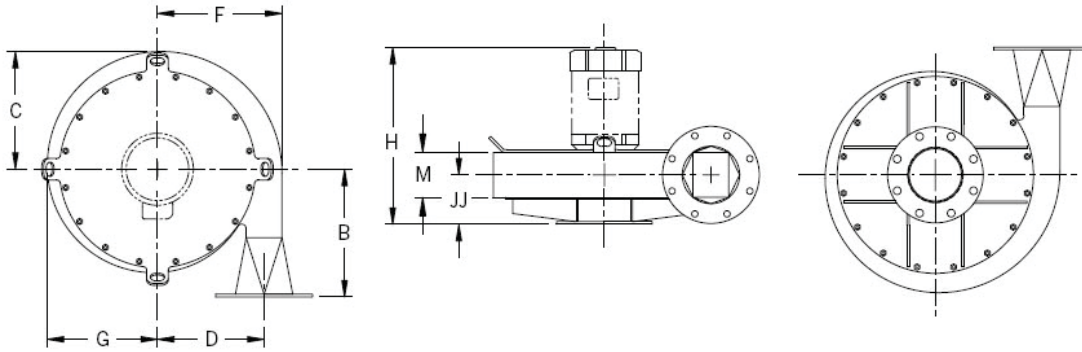

CONVERSIONES DE UNIDADES

VOLUMEN		
TENEMOS	MULTIPLICAR	OBTENEMOS
CFM	0.0004719	m3/seg
CFM	0.02832	m3/min
CFM	1.699	m3/hr
CFM	0.47195	l/seg
CFM	28.317	l/min
m3/seg	2118.9	CFM
m3/seg	60	m3/min
m3/seg	3600	m3/hr
m3/seg	1000	l/seg
m3/seg	60000	l/min
m3/min	35.315	CFM
m3/min	0.0167	m3/seg
m3/min	60	m3/hr
m3/min	16.667	l/seg
m3/min	1000	l/min
m3/hr	0.58858	CFM
m3/hr	0.0167	m3/min
m3/hr	0.0003	m3/seg
m3/hr	0.2778	l/seg
m3/hr	16.667	l/min
l/seg	2.1189	CFM
l/seg	0.001	m3/seg
l/seg	0.06	m3/min
l/seg	3.6	m3/hr
l/seg	60	l/min

VELOCIDAD DE SALIDA		
TENEMOS	MULTIPLICAR	OBTENEMOS
ft/min	0.0167	ft/seg
ft/min	0.00508	m/seg
ft/min	0.3048	m/min
ft/min	18.288	m/hr
ft/min	0.01136	mph
ft/min	0.00987	knots
ft/seg	60	ft/min
ft/seg	0.3048	m/seg
ft/seg	18.288	m/min
m/seg	196.85	ft/min
m/seg	3.2808	ft/seg
m/seg	60	m/min
m/seg	3600	m/hr
m/seg	2.2369	mph
m/seg	1.9425	knots
m/min	3.2808	ft/min
m/min	0.05468	ft/seg
m/min	0.0167	m/seg
m/min	60	m/hr
m/min	0.03728	mph
m/min	0.03238	knots

POTENCIA		
TENEMOS	MULTIPLICAR	OBTENEMOS
HP	745.7	W
HP	0.7457	KW
W	0.00134	HP

PRESION		
TENEMOS	MULTIPLICAR	OBTENEMOS
in wg	0.03607	psi
in wg	0.07343	in Hg
in wg	248.66	Pa
in wg	25.4	mm wg
in wg	1.8651	mm Hg
in wg	0.002454	atm
in wg	2.49	mbar
in wg	0.00249	bar
in Hg	0.49115	psi
in Hg	13.619	in wg
in Hg	3386.4	Pa
in Hg	345.91	mm wg
in Hg	25.4	mm Hg
in Hg	0.03342	atm
Pa	0.000145	psi
Pa	0.004022	in wg
Pa	0.0002953	in Hg
Pa	0.10215	mm wg
Pa	0.007501	mm Hg
Pa	0.0000099	atm
Pa	0.01	mbar
mm wg	0.00142	psi
mm wg	0.03937	in wg
mm wg	0.002891	in Hg
mm wg	9.7898	Pa
mm wg	0.07343	mm Hg
mm wg	0.0000966	atm
mm Hg	0.01934	psi
mm Hg	0.53616	in wg
mm Hg	0.03937	in Hg
mm Hg	133.32	Pa
mm Hg	13.619	mm wg
mm Hg	0.001316	atm

DENSIDAD		
TENEMOS	MULTIPLICAR	OBTENEMOS
lb/ft3	16.02	kg/m3
kg/m3	0.06243	lb/ft3

TEMPERATURA		
TENEMOS	formula	OBTENEMOS
°C	°F=(9/5)*(°C+32)	°F
60		140
°F	°C=(5/9)*(°F-32)	°C
650		343.3333333

ALTITUD		
TENEMOS	MULTIPLICAR	OBTENEMOS
m	3.2808	ft
ft	0.3048	m



EVA & EVP



TURA



EVAD



PFA



VDH



VCL



SWING OUT



TLA

INDUSTRIALES EN BALANCEO S.A. DE C.V.
 Av. La Presa No. 20 Col. Industrial la Presa Tlalnepantla Edo.
 México. C.P. 54187
 Tels y Fax. (55) 5718 0003, 5384 8069, 5384 8070
evisa_ibsa@prodigy.net.mx evisa_ibsa@yahoo.com.mx
www.evisaventiladores.com



MPCA



TURH



EJF

